

# **National Standard for Commercial Vessels**

## **Part C Design and construction**

### **Section 1 Arrangement, accommodation and personal safety**

Edition 1.2

This compilation was prepared by the Australian Maritime Safety Authority on 24 July 2018 taking into account:

- Amendment No. 1, 2016 that was approved by the National Marine Safety Regulator on 7 June 2016 to commence on 10 June 2016; and
- Amendment No.2, 2018 that was approved by the National Marine Safety Regulator on 23 July 2018 to commence on 24 July 2018.

Published by Australian Maritime Safety Authority, GPO Box 2181 Canberra, ACT 2601.

### Copyright



© Australian Maritime Safety Authority 2022

The Australian Maritime Safety Authority encourages the dissemination and exchange of information provided in this publication.

Except as otherwise specified, all material presented in this publication is provided under Creative Commons Attribution 4.0 International licence. This excludes:

- the Commonwealth Coat of Arms
- this AMSA's logo
- content supplied by third parties.

The Creative Commons Attribution 4.0 International Licence is a standard form licence agreement that allows you to copy, distribute, transmit and adapt this publication provided that you attribute the work. The details of the version 4.0 of the licence are available on the Creative Commons website, as is the full legal code for that licence.

### Attribution

The AMSA's preference is that you attribute this publication (and any material sourced from it) using the following wording:

Source:

© Australian Maritime Safety Authority, *National Standard for Commercial Vessels, Part C Design and construction, Section 1 Arrangement, accommodation and personal safety.*

### More information

For inquiries regarding copyright including requests to use material in a way that is beyond the scope of the terms of use that apply to it, please contact us.

### Disclaimer

The Australian Maritime Safety Authority accepts no liability for the accuracy of the information nor its use or the reliance placed on it.

**Foreword**

This Section of the National Standard for Commercial Vessels was prepared as part of the review of the Uniform Shipping Laws (USL) Code. It replaces a number of sections of the USL Code.

This Section is to be read in conjunction with Part B—General Requirements of the National Standard for Commercial Vessels.

	Page
Chapter 1 Preliminary .....	6
1.1 Scope.....	6
1.2 Application.....	6
1.3 Objective.....	6
1.4 Referenced documents.....	6
1.5 Definitions.....	7
Chapter 2 Operating stations.....	10
2.1 Scope.....	10
2.2 Application.....	10
2.3 Required outcome — perception and situational awareness.....	10
2.4 Required outcome — compliance with COLREGS.....	10
2.5 Required outcome — human factors.....	10
2.6 Location of the operating position.....	10
2.7 Vessels of measured length at least 45 m.....	11
2.8 Vessels of measured length less than 45 m.....	11
2.9 Vessels that set sail.....	11
2.10 Dedicated use on passenger vessels of measured length at least 24 m.....	11
2.11 Field of vision from the primary operating station.....	12
2.12 Alternative deemed-to-satisfy solution for field of vision from the operating station.....	15
2.13 Glazing materials and tinting of windows.....	19
2.14 Operating station layout, design and arrangement of navigational systems and equipment.....	19
Chapter 3 Arrangements for provision of navigation signals.....	21
3.1 Scope.....	21
3.2 Application.....	21
3.3 Required outcome — collision avoidance.....	21
3.4 Provision of masts and positions for signals.....	21
Chapter 4 Accommodation spaces.....	22
4.1 Scope.....	22
4.2 Application.....	22
4.3 Minimum clear height between decks.....	22
4.4 Passenger accommodation.....	22
4.5 Berthed accommodation.....	23
4.6 Sanitary arrangements.....	23
4.7 Deemed-to-satisfy solutions.....	24
4.8 General requirements for accommodation where fitted.....	26
4.9 Crew accommodation — source of deemed-to-satisfy solution.....	27
4.10 Crew sleeping accommodation.....	27
4.11 Passenger accommodation.....	30
4.12 Facilities for sick or injured persons.....	35
4.13 Crew mess facility.....	35
4.14 Galley and food storage facilities.....	36
4.15 Sanitary facilities.....	37
4.16 Crew cloak and laundry facilities.....	39
4.17 Potable water.....	39
Chapter 5 Access, escapes and evacuation.....	40
5.1 Scope.....	40
5.2 Definitions.....	40
5.3 Required outcome — escape from hazards within spaces on the vessel.....	40
5.4 Required outcome — redundancy in escapes.....	40

	Page
5.5	Required outcome — facilitate movement for evacuation..... 40
5.6	Required outcome — facilitate movement between decks..... 41
5.7	Required outcome — accommodate the needs of a large proportion of the population..... 41
5.8	Escape from spaces..... 41
5.9	Evacuation paths..... 47
5.10	Doors and hatches in escape or evacuation routes..... 49
5.11	Passageways ..... 50
5.12	Handrails ..... 51
5.13	Walkways, stairways and ladders ..... 52
5.14	Safety information ..... 57
Chapter 6	Personal safety..... 59
6.1	Scope..... 59
6.2	Required outcome — Safe conduct of operations — lighting..... 59
6.3	Protection of persons from the elements ..... 59
6.4	Bulwarks and guard rails..... 60
6.5	Required outcome — protection from machinery..... 60
6.6	Required outcome — protection from slip and fall hazards ..... 60
6.7	Required outcome — protection from hearing damage..... 60
6.8	Required outcome — safe access to and from vessels ..... 60
6.9	Required outcome — pilot launch design and equipment..... 61
6.10	Required outcome — recovery of persons who fall overboard ..... 61
6.11	Protection of persons from the elements ..... 61
6.12	Bulwarks and guardrails..... 63
6.13	Protection from hazardous plant..... 70
6.14	Safe movement of persons on vessels..... 71
6.15	Protection from excessive noise levels..... 71
6.16	Access to and from the vessel ..... 72
6.17	Pilot launches..... 76
Annex A	Methodology for determining the minimum required aggregate width of doors, stairways, corridors and walkways serving a space..... 79

## Chapter 1 Preliminary

### 1.1 Scope

This Section:

- (a) specifies minimum requirements for the arrangement, accommodation and personal safety on vessels; and
- (b) relies on NSCV Part B and NSCV Part C Section 4; and
- (c) does not specify every requirement for all relevant national or state legislation for the arrangement, accommodation and personal safety on a vessel.

*Note* Users should refer to relevant legislation including occupational health and safety legislation and legislation about access by persons with disabilities.

### 1.2 Application

This Section:

- (a) applies to all vessels except special vessels to which NSCV Part F applies; and
- (b) does not affect any Section in NSCV Part F that states that this Section applies to a vessel.

### 1.3 Objective

The objective of this Section is:

- (a) to manage risks to persons onboard vessels; and
- (b) to address risks related to the arrangement of vessels, identifiable in the early stage of a vessel's design.

### 1.4 Referenced documents

Each document mentioned in the following table:

- (a) is referenced in this Section; and
- (b) is the latest revision of the document, including amendments, unless stated otherwise.

<b>Publisher</b>	<b>Document</b>
Australian Maritime Safety Authority	<i>National Standard for Commercial Vessels (NSCV)</i> <i>Part B—General Requirements</i> <i>Part C—Design and Construction</i> <i>Part F—Special Vessels</i> <i>Marine Order 504 (Certificates of operation and operation requirements — national law) 2018 (Marine Order 504)</i>

<b>Publisher</b>	<b>Document</b>
Commonwealth of Australia	<i>Disability Discrimination Act 1992</i> <i>Disability Standards for Accessible Public Transport Guidelines 2004</i>
International Labour Organization	<i>Maritime Labour Convention 2006 (MLC 2006)</i>
International Maritime Organization	<i>Code on Noise Levels On Board Ships 2012</i> <i>The International Regulations for Preventing Collisions at Sea 1972 (COLREGS)</i> <i>Fire Safety Systems Code</i> <i>International Convention on Load Lines (Load Lines Convention)</i> <i>International Convention for the Safety of Life at Sea (SOLAS)</i>
International Organization for Standardization	<i>ISO 7061:1993 — Shipbuilding — Aluminium shore gangways for seagoing vessels</i> <i>ISO 15085:2003 — Small craft — Man-overboard prevention and recovery</i>
Lloyd's Register	<i>Rules and Regulations for the Classification of Ships (Lloyd's Rules)</i>
Standards Australia	<i>AS 1657-1992 — Fixed platforms, walkways, stairways and ladders — Design, construction and installation</i> <i>AS 1428.1-2009 — Design for access and mobility — Part 1: General requirements for access — New building work</i> <i>AS/NZS 2080-2006 — Safety Glazing for Land Vehicles</i> <i>AS 2227-2006 — Yachting harnesses and lines — Conventional lines</i>

## 1.5 Definitions

For this Section, the following terms have the meaning given by NSCV Part B:

accommodation spaces	crew	depth
fast craft	fish	fishing vessel
hazard	hire and drive vessel	length
maximum speed	measured length	non-passenger vessel
operational area	operational area categories	owner
passenger	passenger vessel	risk
service categories	sheltered waters	superstructure

vessel

vessel use  
categories.

For this Section:

**accommodation ladder** means a step ladder with flat or curved steps and handrails, enabling a person to embark or disembark the vessel.

**clear deck area** means deck space that is unencumbered and available for use by passengers and crew.

**embarkation station** means a location on a vessel intended for the orderly and rapid embarkation of persons into survival craft.

**evacuation path** means a path:

- (a) nominated to facilitate the orderly and rapid movement of persons to an embarkation station; and
- (b) that starts at each point at which escape routes from different spaces merge.

**gangplank** means a board or walkway that provides a removable footway between a vessel and the shore intended for short term deployment and suited for use only by:

- (a) the crew; or
- (b) able-bodied persons other than the crew, but only while under supervision of members of the crew.

**gangway** means a board or walkway used as a removable footway between a vessel and the shore intended for deployment:

- (a) over longer periods; or
- (b) for use by the general public.

**general purpose deck** means an open deck that is neither a special purpose deck or a special working deck.

**high capacity escape** means an escape of a type that facilitates rapid movement of persons (eg full height openings in boundaries leading to adjacent spaces, stairways or walkways).

**low capacity escape** means an escape that has limited capacity to facilitate rapid movement of persons (eg narrow full height openings or restricted height openings leading to adjacent spaces, stairways or walkway, hatches, windows, portlights or side scuttles with ladder access if necessary).

**minimum headroom**, for a space, means the height remaining in the space after deducting beams, deck-head linings, floor coverings and light fittings.

**operating compartment** means a wholly or partially enclosed operating station.

**operating position** means the location in an operating station that the person responsible for navigating the vessel would be expected to occupy when undertaking his or her functions under normal conditions of operation.

*Note 1* The operating position may be remote from the helm on a vessel that has a separate helmsman.



---

*Note 2* On a vessel not having a separate helmsman, the operating position is also the steering position.

***operating station*** means any location on a vessel:

- (a) that is equipped with the necessary means for navigation, manoeuvring and communication; and
- (b) from where the functions of navigating, manoeuvring, communication, commanding, conning and lookout are carried out.

***operational workspace*** means an enclosed space that:

- (a) is normally accessible to persons during normal operation of the vessel; and
- (b) is not an accommodation space.

***passageway*** means an aisle that:

- (a) is set aside for the passage of persons past furniture and fittings within a space; and
- (b) is not enclosed by bulkheads on both sides.

***primary access*** means the means of access used when the vessel is in normal operation

***primary steering position*** means a steering position, within a primary operating station, that complies with the requirements for field of vision from the operating position mentioned in clause 2.11 or 2.12.

***primary operating station*** means an operating station that complies with the requirements for field of vision mentioned in clause 2.11 or 2.12.

***secondary steering position*** means a steering position that:

- (a) is not a primary steering position; and
- (b) is intended for a specific navigation function or for the special purpose of the vessel.

***special purpose deck*** means an open deck:

- (a) that can be accessed by passengers; and
- (b) that is used for the special purpose of the vessel; and
- (c) for which full height bulwarks would significantly interfere with the special purpose or cause safety risks from the special purpose.

***special working deck*** means an open deck:

- (a) for which full height bulwarks or guardrails would significantly interfere with the special purpose of the vessel or cause safety risks arising from the special purpose; and
- (b) that is only accessed by:
  - (i) crew or special personnel; or
  - (ii) passengers for the purpose of engaging in adventure activities.

***spiral stairway*** means a stair with a circular plan, comprised of tapered treads that radiate from a common centre or several radii.

**winders** means tapered treads within a straight flight that are used to change direction of the stair.

**steering position** means the location in the operating station where the means for controlling the vessel during navigation are located.

**tapered tread** means a stair tread with a walking area that grows smaller towards an end.

**walkway** means a passageway that is either level or sloping from the surrounding floor or level, including a continuous structure or steps with landings.

## Chapter 2 Operating stations

### 2.1 Scope

This Chapter specifies minimum requirements for the location and arrangement of the operating station on a vessel.

### 2.2 Application

This Chapter applies to each operating station on a vessel.

### Required outcomes

#### 2.3 Required outcome — perception and situational awareness

A vessel must be arranged to ensure that the person operating the vessel has sufficient information to identify navigational hazards, assess the risks and take appropriate measures to control the risks in both normal and abnormal conditions of operation.

#### 2.4 Required outcome — compliance with COLREGS

A vessel must be arranged to enable the person operating the vessel to comply at all times with the person's obligations under COLREGS.

#### 2.5 Required outcome — human factors

A vessel must be arranged to eliminate or reduce to acceptable levels the risk of operator error or fatigue arising due to the design and arrangement of the operating station.

### Deemed-to-satisfy solutions

#### 2.6 Location of the operating position

The operating position must:

- (a) allow the operator to conveniently and rapidly control the heading, speed and direction of the vessel while remaining alert for navigational hazards; and
- (b) be located and arranged to suit the range of crew stature mentioned in **Table 1**.

**Table 1 — Requirements for deemed-to-satisfy vertical eye positions above the deck**

	<b>Standing: (including 20 mm footwear) above deck (mm)</b>	<b>Seated: above the surface of the compressed seat (mm)</b>
High eye position	1770	860
Low eye position	1550	745

**2.7 Vessels of measured length at least 45 m**

A required outcome mentioned in clauses 2.3 to 2.5 is satisfied for a vessel of measured length at least 45 m if the vessel complies with the deemed-to-satisfy solutions mentioned in clauses 2.10, 2.11, 2.13 and 2.14 that apply to the vessel.

**2.8 Vessels of measured length less than 45 m**

A required outcome mentioned in clauses 2.3 to 2.5 is satisfied for a vessel of measured length less than 45 m if the vessel complies with:

- (a) the deemed-to-satisfy solutions, mentioned in clauses 2.10, 2.13 and 2.14, that apply to the vessel; and
- (b) a deemed-to-satisfy solution, mentioned in clause 2.11 or 2.12, that applies to the vessel.

**2.9 Vessels that set sail****2.9.1 Operating under power alone**

A vessel capable of carrying sail must be arranged to ensure compliance with clause 2.7 or 2.8 when operating under power alone.

**2.9.2 Operating under sail**

A vessel under sail need not comply with the full requirements of clause 2.11 or 2.12 to the extent that a sail when set interferes with the field of vision from the operating station.

**2.10 Dedicated use on passenger vessels of measured length at least 24 m**

On a passenger vessel of measured length at least 24 m, the primary operating station:

- (a) must be separated from passenger spaces; and
- (b) must not be used for purposes other than navigation, communications, provision of watchkeeper amenities or other functions essential to the safe operation of the craft, its engines, passengers and cargo.

## 2.11 Field of vision from the primary operating station

The vessel must have at least 1 operating station that complies with the criteria mentioned in **Table 2** (see also **Figure 1** and **Figure 2**).

*Note* For alternative deemed-to-satisfy criteria for vessels less than 45 m measured length — see clause 2.12.

**Table 2 — Field of vision from the operating compartment**

Item	Criteria
<b>View forward from the operating position</b>	
2.11.1	The view from the operating position, of the sea surface forward of the bow, must be clear and unobstructed for at least the lesser of 500 m or a distance that is twice the vessel's measured length. The view must be clear for at least 10° on either side of the bow under all conditions of draft, trim and deck cargo.
2.11.2	The clear sectors between blind sectors must be at least 5°. However, in the view mentioned in item 2.11.1, each individual blind sector must not exceed 5°.
2.11.3	Framing between operating compartment windows must not be installed immediately forward of any operating position.
<b>Horizontal field of vision from the operating position</b>	
2.11.4	The horizontal field of vision from the operating position must extend over an arc of at least 225°, from right ahead to at least 22.5° abaft the beam on either side of the vessel.
2.11.5	A blind sector caused by cargo, cargo gear or other obstructions outside the operating compartment forward of the beam that obstructs the view of the sea surface as seen from the operating position must not exceed 10°.
2.11.6	The total arc of blind sectors forward of the beam must not exceed 20°.
2.11.7	Framing between operating compartment windows must be kept to a minimum.
<b>Horizontal field of vision from the steering position</b>	
2.11.8	From the main steering position, the horizontal field of vision must extend over an arc from right ahead to at least 60° on each side of the vessel.
<b>Vertical field of vision from the operating position</b>	
2.11.9	There must be no obstruction to obscure the forward view mentioned in item 2.11.1 when viewed from the low eye position mentioned in clause 2.6.
2.11.10	For a vessel of at least 45 m measured length, the upper edge of any operating compartment front windows, awning or other similar obstruction must allow a forward view of the horizon, for a

---

person with a height of eye of 1770 mm above the deck at the operating position, when the vessel is pitching in heavy seas.

- 2.11.11 For a vessel less than 45 m measured length, the upper edge of any operating compartment front windows, awning or other similar obstruction must allow a forward view of the horizon when viewed from the high eye position mentioned in clause 2.6.

#### **View to the sides of the vessel**

- 2.11.12 The operating station must be arranged with at least 1 location on each side that provides a horizontal field of vision extending over an arc at least 225°, from at least 45° on the opposite bow through right ahead and then from right ahead to right astern through 180° on the same side of the vessel.
- 2.11.13 For a vessel of at least 45 m measured length and at the least operational draft, the side of the vessel on each side must be visible from a location in the operating station.
- 2.11.14 For a vessel of less than 45 m measured length and at the least operational draft, the sea surface at a transverse distance of 1 500 mm from the maximum beam throughout a vessel length along each side must be visible from a location in the operating station.

#### **Operating compartment windows**

- 2.11.15 On a vessel of at least 45 m measured length, the front windows of any operating compartment must be inclined from the vertical plane top out, at an angle of at least 10° and not more than 25°.
- 2.11.16 On a vessel of at least 45 m measured length, polarised or tinted windows must not be fitted to windows in the operating compartment.
- 2.11.17 On a vessel of less than 45 m measured length, polarised or tinted windows must not be fitted to windows in the forward-facing horizontal sectors mentioned in item 2.11.4.
- 2.11.18 A means must be provided for maintaining clear vision at all times, regardless of weather conditions, through at least 2 of the front windows of an operating compartment. The 2 windows must be located so that the clear view is readily obtained from:
- (a) the operating position; and
  - (b) if the steering position is not the same as the operating position — the steering position.
-

**Figure 1 — Field of vision from the operating station (clause 2.11)**

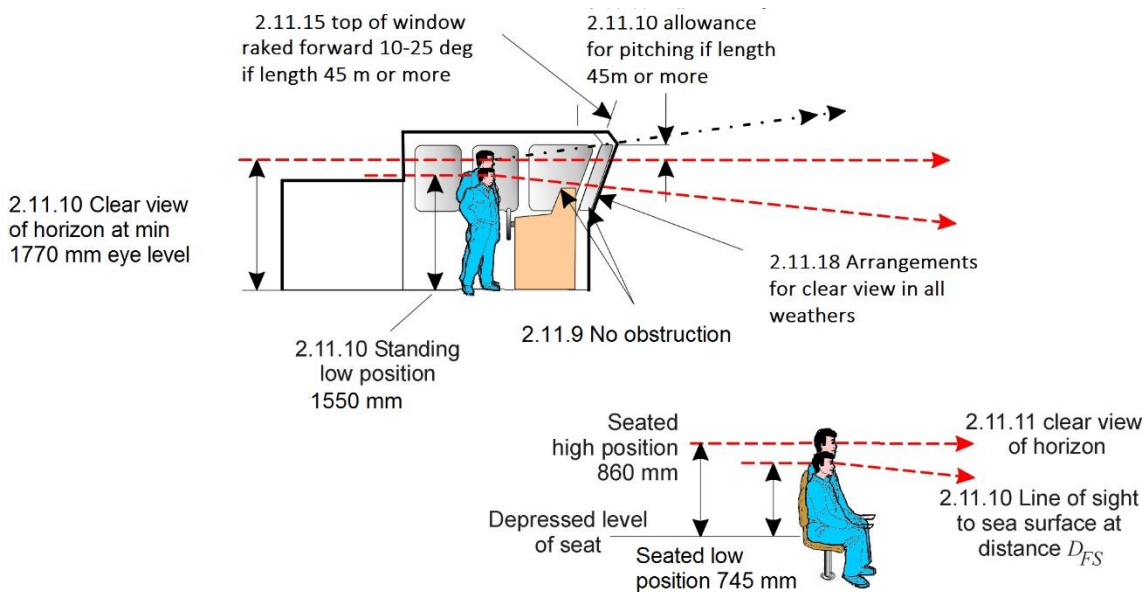

**Figure 2 — Field of vision from the operating station (clause 2.11)**

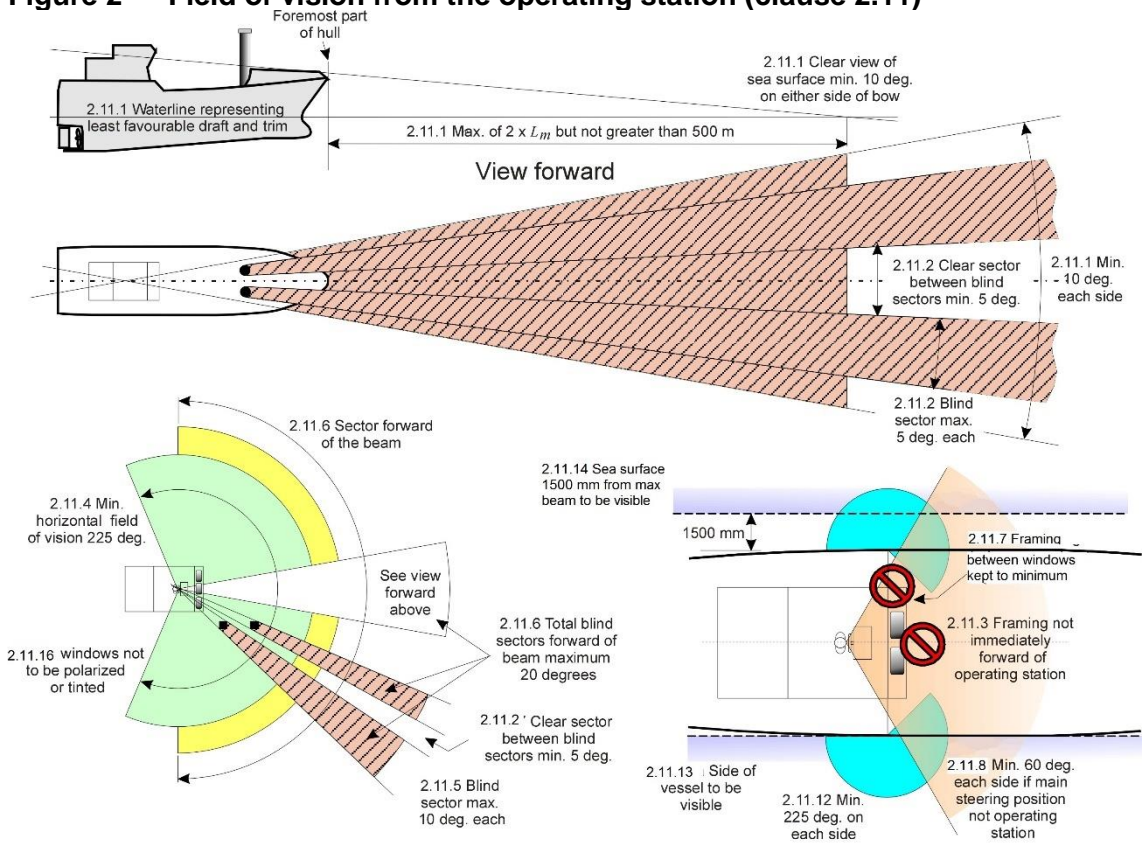

## 2.12 Alternative deemed-to-satisfy solution for field of vision from the operating station

### 2.12.1 Scope

#### 2.12.1.1 Requirements

Clause 2.12 sets out requirements, for field of vision from the operating station, that apply to the seated or standing position.

#### 2.12.1.2 Vessel that can meet standard of only 1 operating position

If the vessel could be operated from both the seated and standing positions, but can only meet the standard from either the standing position or the seated position, the operating station must be labelled to indicate that visibility from the non-compliant position is limited.

### 2.12.2 Application

This clause applies to a vessel less than 45 m measured length as an alternative to the criteria mentioned in clause 2.11.

### 2.12.3 Definitions

In this clause:

*aft sector of visibility* means the aft horizontal arc measured between 90° to port from straight astern and 67.5° to starboard from straight astern, shown in Figure 4.

*forward sector of visibility* means the forward horizontal arc measured between 90° to port from straight ahead and 112.5° to starboard from straight ahead, shown in Figure 4.

*horizontal range of visibility* means the sum of the forward sector and the aft sector of visibility.

*vertical range of visibility* means the range between the lowest unobstructed line of vision from the low eye position and the highest unobstructed line of vision from the high eye position, shown in Figure 3.

### 2.12.4 Condition of vessel

In determining whether the vessel complies with clause 2.12, the vessel is taken to have:

- (a) fuel and water tanks filled; and
- (b) the weights for outboard engines and batteries at the highest rating for which the vessel is intended to be equipped and operated.

This clause applies at all vessel speeds unless the vessel is operating at high trim angles during the transition between displacement and planing modes.

### 2.12.5 Applicable criteria

The primary operating station must be designed and constructed to comply with the criteria mentioned in Table 3. The criteria are further explained by the diagrams in Figure 3 and Figure 4.

**Table 3 — Alternative criteria for field of vision from the operating compartment on vessels less than 45 m measured length**

Item	Criteria
------	----------

**View forward from operating position**

- 2.12.5.1 A clear sector of visibility of at least 30° must be provided directly in front of the operating position that extends throughout the vertical range of visibility mentioned in item 2.12.5.2 and extends horizontally from straight ahead at least 15° to the left and at least 15° to the right of the eye positions (both low and high).
- 2.12.5.2 The vertical range of visibility in the forward clear 30° sector of visibility must extend:
- from a horizontal line from the high eye position at the operating position; to
  - a line between a point on the surface of the water, a distance  $D_{FS}$  ahead of the vessel and measured from the bow, through the highest point of lower obstructed visibility within the forward clear 30° sector of visibility to the low eye position.

For paragraph (b),  $D_{FS}$  is:

Measured length ( $L_m$ ) of the vessel (m)	Distance $D_{FS}$ measured from the fore part of the vessel to the sea surface (m)		
	Powered vessels that do not set sail	Vessels that set sail, when under power alone	
		$\geq 12$ knots	$< 12$ knots
$< 12.5$	$4 \times L_m$	$4 \times L_m$	$8 \times L_m$
12.5 to $< 25$	50 m	50 m	100 m
25 to $< 45$	$2 \times L_m$	$2 \times L_m$	100 m

- 2.12.5.3 Fixed obstructions to vision from the operating position within the forward 30° sector of visibility must be limited to essential hardware, eg cleats, deck stanchions, navigation lights and windshield wipers.
- 2.12.5.4 Obstructions to visibility within the forward 30° sector must be arranged to avoid significant enlargement by overlapping when viewed at positions within the range of high to low eye positions.
- 2.12.5.5 Outside the clear sector of visibility from the operating position throughout the horizontal arc measured from 90° to port and 112.5° to starboard, obstructions must be kept to a minimum such that normal movements of the operator's head will permit unobstructed visibility.

**Horizontal field of vision**

- 2.12.5.6 If permanent obstructions to vision exist in the aft 157.5° sector of visibility, unobstructed visibility must be maintained by alternative means.



**Vertical field of vision**

- 2.12.5.7 The vertical range of visibility from the operating station throughout the entire horizontal range of visibility, outside the forward clear 30° sector of visibility, must extend from a horizontal line from the high eye position to a line from the low eye position to a point on the water's surface at a distance no greater than the distance  $D_{FS}$  mentioned in column 2 of the table in item 2.12.5.2, measured from the deck edge, gunwale or stern.

**Operating compartment windows**

- 2.12.5.8 Polarised and tinted windows must not be fitted in the operating compartment within the forward facing sector defined by:
- (a) the horizontal arc from directly forward to 112.5° on the starboard side;  
and
  - (b) the horizontal arc from directly forward to 112.5° on the port side.
- 2.12.5.9 A means must be provided for maintaining a clear view at all times, regardless of weather conditions, through at least 1 of the front windows of an operating compartment.
-

**Figure 3 — Alternative field of vision from the operating station (clause 2.12)**

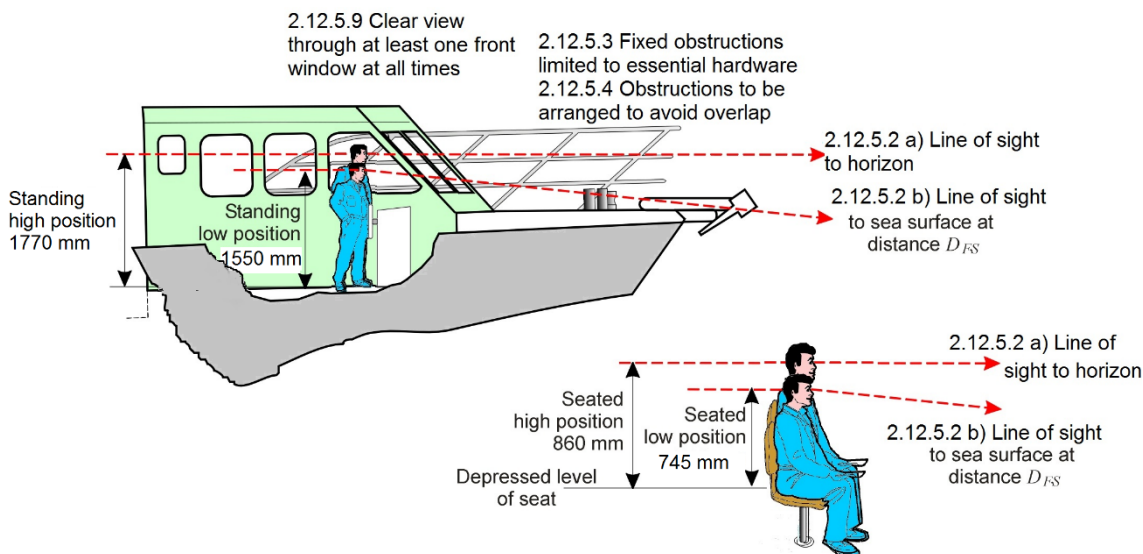

**Figure 4 — Alternative field of vision from the operating station (clause 2.12)**

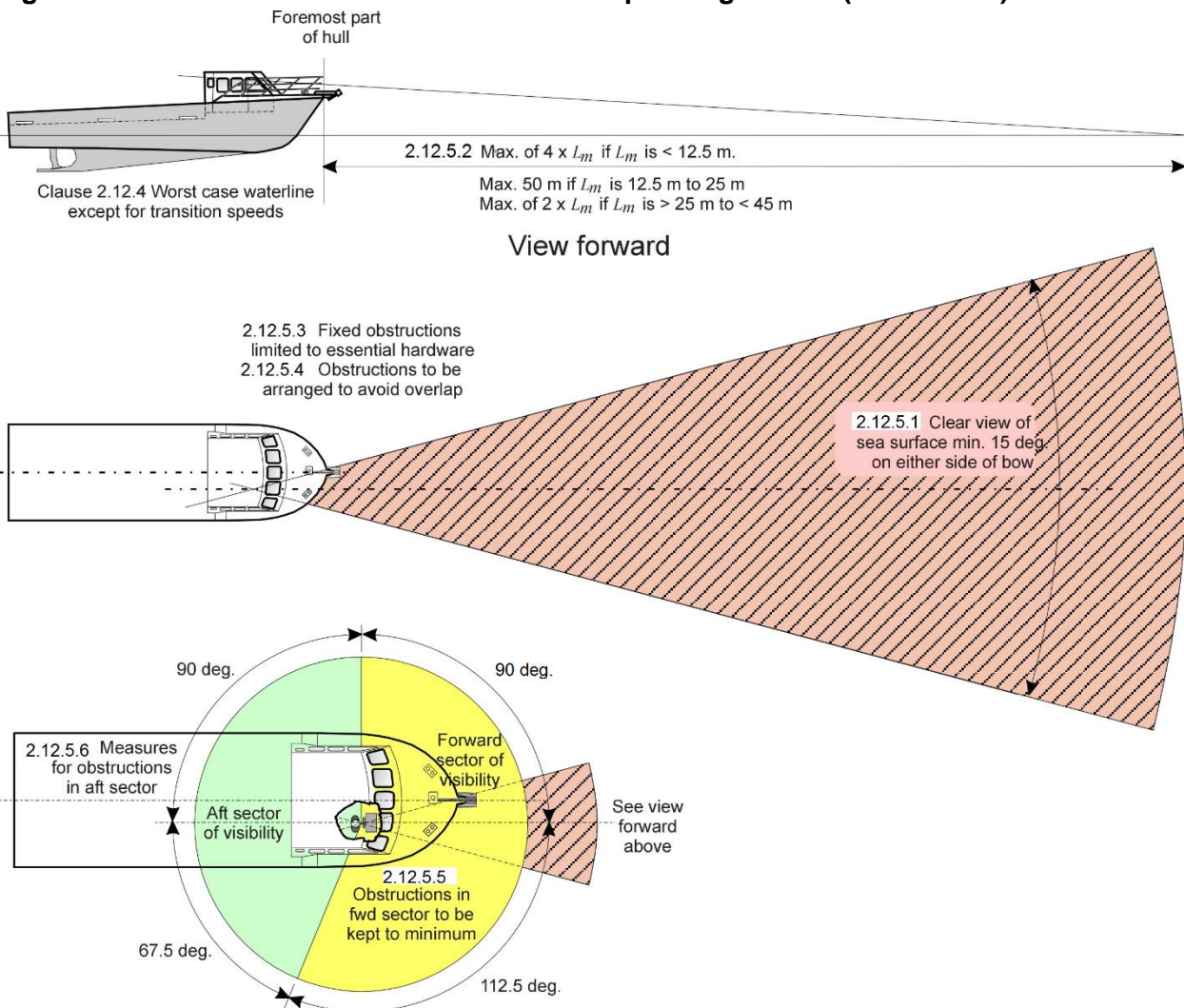

## 2.13 Glazing materials and tinting of windows

### 2.13.1 Windows used for navigation

Windows used for navigation must be glass or an equivalent material that has low levels of distortion and is resistant to scratching and crazing over time.

### 2.13.2 Tinted or polarised windows

#### 2.13.2.1 *Minimum light transmission of tinted glazing materials*

Glazing material used in a window that is used for the safe navigation of the vessel by a person at an operating station must have a light transmission of at least 70%, measured in accordance with *AS/NZS 2080-2006 — Safety Glazing for Land Vehicles*.

*Note* Clauses 2.11.16 and 2.12.5.8 limit the use of polarised and tinted windows in the operating compartment.

#### 2.13.2.2 *Colour of tinted glazing materials*

Any tint of glazing materials used in a window mentioned in clause 2.13.2.1 must not interfere with recognition of the colour of lights seen through the tinted material.

### 2.13.3 Use of tinted blinds

A window within the forward sector may have a tinted blind of Mylar or similar material only if the window and blind combination has:

- (a) low optical distortion; and
- (b) light transmission and colour that complies with clauses 2.13.2.1 and 2.13.2.2.

## 2.14 Operating station layout, design and arrangement of navigational systems and equipment

### 2.14.1 Facilitation of operator obligations

The layout of the operating station must be designed to facilitate the following:

- (a) maintaining a proper lookout from the operating station in accordance with COLREGS;
- (b) use of controls for steering, propulsion and trim so that during use, operator hand contact can be maintained without movement of the operator's eye below the eye position for which the vessel is designed;
- (c) the proper monitoring and use of equipment essential for command, navigation, manoeuvring without compromising the operator's obligations to operate the vessel in accordance with COLREGS;
- (d) the proper monitoring and use of communications equipment without interfering with the primary navigational functions in the operating station.

### 2.14.2 Distractions

The operating station must be located and arranged to prevent or minimise distractions that might interfere with the vigilance of the operator.

### 2.14.3 Fatigue

The operating station must be located and arranged to prevent or minimise fatigue by avoiding any excessive or unnecessary effort required of the operator in fulfilling his or her duties.

### 2.14.4 Display of essential information

Consoles and equipment within the operating station must:

- (a) be designed and constructed to provide convenient and continuous access to information essential for controlling and monitoring the vessel and its safety, in full daylight and in darkness; and
- (b) have information presented in a clear and unambiguous manner using standardised symbols and coding systems for controls and displays.

### 2.14.5 Console layout

Indicators and controls in consoles must:

- (a) be arranged to reduce the risk of adverse consequences arising from inadvertent error in use; and
- (b) be grouped to facilitate their correct operation; and
- (c) be isolated from other controls if the mistaken operation of the controls would cause a serious reduction in safety.

### 2.14.6 Lighting

#### 2.14.6.1 *Illumination of instrumentation and control devices*

It must be possible to discern displayed information and control devices in daylight and at night.

#### 2.14.6.2 *Control over lighting levels*

The operating station must be arranged and equipped with sufficient control over lighting sources and lighting levels to allow the operator, during hours of darkness, to attain and maintain the levels of dark adaption that may be required to fulfil the operator's obligations under COLREGS.

#### 2.14.6.3 *Glare and reflections to be avoided*

Care must be taken to avoid glare and stray image reflection in way of the operating station.

### 2.14.7 Operating stations equipped with a seat

An operating station on a vessel of less than 45 m measured length may incorporate a seat that is arranged to be longitudinally or vertically adjustable.

### 2.14.8 Operating position — seated and standing positions do not both comply

If an operating position complies with clause 2.12.5 from the seated or the standing position but not from both the seated and standing positions, and the vessel could still be operated from the position that does not comply with clause 2.12.5, a clearly visible notice must be attached to the operating position stating:

**WARNING**

Visibility is limited when seated/standing [*choose as applicable*] at this operating position

Maintain lookout as required by COLREGS

**2.14.9 More than 1 steering position**

On a vessel having more than 1 steering position, a steering position that is located where a person not being crew might have access must be provided with a facility to disengage the controls when not in use.

**2.14.10 Secondary steering positions**

A secondary steering position located in the primary operating station or elsewhere on the vessel must have a clearly visible notice attached to the secondary steering position stating:

**WARNING**

Visibility from this steering position is limited

Maintain lookout as required by COLREGS

**Chapter 3 Arrangements for provision of navigation signals****3.1 Scope**

This Chapter specifies minimum requirements for the the arrangement of a vessel to provide for the navigation signals mentioned in COLREGS.

**3.2 Application**

This Chapter applies to each vessel that is subject to COLREGS.

**Required outcome****3.3 Required outcome — collision avoidance**

A vessel must have means to inform other vessels of its location, nature, size, course and status, to help avoid collision or contact.

**Deemed-to-satisfy solutions****3.4 Provision of masts and positions for signals**

A vessel must be arranged to exhibit the lights and shapes mentioned in COLREGS for the vessel's intended operations.

## Chapter 4 Accommodation spaces

### 4.1 Scope

This Chapter specifies minimum requirements for accommodation spaces on vessels, including passenger accommodation spaces and crew accommodation spaces.

*Note* *accommodation spaces* is defined in NSCV Part B.

### 4.2 Application

A vessel must be assigned an accommodation level mentioned in **Table 4**.

**Table 4 — Assigned accommodation levels**

Level	All vessels in operational area	Plus other vessels having a length of voyage without access to shore-based sleeping facilities
AL72+	A	Operational Area B, C, D or E greater than 72 hours
AL36-72		Operational Area B, C, D or E greater than 36 hours and up to 72 hours
AL12-36	B	Operational Area C, D or E greater than 12 hours and up to 36 hours
AL<12		Operational Area C, D or E less than 12 hours

### Required outcomes

#### 4.3 Minimum clear height between decks

##### 4.3.1 Required outcome — protection from head and neck injury

The space between deck and deck head on a vessel must be sufficient for persons to avoid head or neck injury from accidental physical contact with the deckhead, deck beams or other items that project below the deck head.

##### 4.3.2 Required outcome — facilitation of rapid movement

The space between deck and deck head on a vessel must allow the rapid movement of persons along escape and evacuation routes if there is an emergency.

#### 4.4 Passenger accommodation

##### 4.4.1 Required outcome — protection from excessive motions

A vessel must be arranged to reduce the risks to persons during excessive vessel motions.

##### 4.4.2 Required outcome — escape from hazards within a space

Sufficient free space must be provided to allow passengers to move away quickly from the immediate vicinity of hazards that might develop within the space.

**4.4.3 Required outcome — safe movement of persons**

Sufficient free space must be provided to allow the movement of passengers without undue physical contact with others in the space.

**4.5 Berthed accommodation****4.5.1 Required outcome — fatigue management**

A vessel must be arranged to provide an environment that facilitates the rest and sleep of crew members and passengers.

**4.5.2 Required outcome — disease and other risks to health**

Accommodation on a vessel must facilitate the prevention of the spread of disease and minimise other risks to health.

**4.5.3 Required outcome — sufficient personal space**

Sufficient personal space must be provided in sleeping accommodation to minimise interference that may compromise the harmony between persons on board the vessel.

**4.5.4 Required outcome — facilitation of social harmony**

If crew are expected to live on board for extended periods, accommodation must be arranged to maintain social harmony on board.

**4.6 Sanitary arrangements****4.6.1 Required outcome — protection of persons from hazardous behaviour**

A vessel must have appropriate and sufficient toilet facilities so that persons on board can access them without engaging in hazardous behaviour (eg leaning over rails and bulwarks, or being exposed to the force of the sea).

**4.6.2 Required outcome — promotion of hygienic behaviour**

A vessel must have:

- (a) sufficient and appropriate toilet and washing facilities to promote and facilitate hygienic behaviour; and
- (b) sanitary arrangements protecting the privacy of a person using them and promoting their use.

**4.6.3 Required outcome — prevention of growth and transmission of micro-organisms**

The following measures must be taken to ensure the prevention of the growth and transmission of micro-organisms on a vessel:

- (a) collection, transportation and disposal of human waste in a manner protecting the health of persons and preventing the transmission of disease;
- (b) sanitary arrangements that:
  - (i) facilitate regular and effective cleaning; and
  - (ii) avoid the build up of unsanitary substances; and
  - (iii) promote sanitary device use.

**4.7 Deemed-to-satisfy solutions**

For this Section, the accommodation is deemed-to-satisfy the required outcomes in clauses 4.3 to 4.6 if it meets the requirements mentioned in **Table 5**.



**Table 5 — Application of deemed-to-satisfy clauses for different accommodation levels**

<b>Clause</b>	<b>AL&lt;12</b>	<b>AL12-36</b>	<b>AL36-72</b>	<b>AL72+</b>
4.8 General requirements for accommodation where fitted				
4.8.1 Minimum headroom	Applies	Applies	Applies	Applies
4.8.2 Control of vermin and disease	Applies	Applies	Applies	Applies
4.8.3 Ventilation	Applies	Applies	Applies	Applies
4.8.4 Temperature control			Applies	Applies
4.8.5 Lighting	Applies	Applies	Applies	Applies
4.8.6 Noise and vibration	Applies	Applies	Applies	Applies
4.9 Crew accommodation — source of deemed-to-satisfy solution	Applies	Applies	Applies	Applies
4.10 Crew sleeping accommodation				
4.10.1 Application			Applies	Applies
4.10.3 Dedicated space			Applies	Applies
4.10.4 Arrangement	Applies	Applies	Applies	Applies
4.10.5 Openings into sleeping accommodation spaces			Applies	Applies
4.10.6 Crew per sleeping room			Applies	Applies
4.10.7 Floor area			Applies	Applies
4.10.8 Berths		Applies	Applies	Applies
4.10.8.6 Fitout			Applies	Applies
4.11 Passenger accommodation				
4.11.1 Maximum permitted number of passengers having access to a	Applies	Applies	Applies	Applies
4.11.2 Spaces for passengers other than sleeping accommodation				
4.11.2.1 Clear deck area	Class 1 only	Class 1 only	Class 1 only	Class 1 only
4.11.2.2 Seating accommodation	Applies	Applies	Applies	Applies
4.11.3 Sleeping accommodation for passengers			Applies	Applies
4.11.4 Access for persons with disabilities	Some Class 1	Some Class 1	Some Class 1	Some Class 1
4.12 Facilities for sick or injured persons				Applies
4.13 Crew mess facility			Applies	Applies
4.14 Galley and food storage facilities			Applies	Applies
4.15 Sanitary facilities	Applies with exceptions	Applies with exceptions	Applies	Applies
4.16 Crew cloak and laundry facilities	Applies with exceptions	Applies with exceptions	Applies with exceptions	Applies
4.17 Potable water	Applies with exceptions	Applies	Applies	Applies

## **4.8 General requirements for accommodation where fitted**

### **4.8.1 Minimum headroom**

An accommodation space on a vessel must have a minimum headroom of at least:

- (a) for a vessel of at least 35m measured length — 1.98m;
- (b) for a vessel of less than 35m measured length — 1.9m.

### **4.8.2 Control of vermin and disease**

#### **4.8.2.1 Materials**

Materials used to construct internal bulkheads, deckheads, panelling and sheeting, and floors and joinings on a vessel must be chosen and installed so that the materials:

- (a) facilitate and withstand periodic cleaning, washing down and drying; and
- (b) prevent the harbouring of vermin and insects.

#### **4.8.2.2 Condensation and moisture**

Accommodation spaces must be arranged to ensure that:

- (a) excessive condensation on exposed internal bulkheads or deckheads is prevented; and
- (b) decks subject to moisture in accommodation spaces have surfaces impervious to damp.

#### **4.8.2.3 Drainage**

A vessel must have a way of draining accommodation spaces if water enters the vessel.

### **4.8.3 Ventilation**

All enclosed accommodation spaces must be ventilated at all times as follows:

- (a) the system of ventilation must supply air free of engine exhaust and other contaminants;
- (b) a vessel of at least 25 m measured length must have mechanical ventilation for accommodation located below the bulkhead deck, facilitating air movement in all weather conditions and climates;
- (c) power for the operation of the mechanical ventilation must be available at all times when the crew is living or working on board.

### **4.8.4 Temperature control**

A vessel must have the following temperature control measures:

- (a) a vessel assigned accommodation level AL72+ or AL36-72 must be designed to have a temperature range in crew accommodation spaces of between 14°C and 30°C for at least 95% of the time;
- (b) for a vessel operating throughout all regions of Australia — active means of temperature control to provide heating and cooling must be fitted;

- (c) if the vessel operates in a region with a 5<sup>th</sup> percentile annual mean minimum temperature of 14°C or more, heating does not need to be provided;
- (d) if the vessel operates in a region with a 95<sup>th</sup> percentile annual mean maximum temperature of 30°C or less, cooling does not need to be provided;
- (e) the system of heating or cooling must be operable at all times when persons are living or working on board;
- (f) for a vessel of at least 35 m measured length — paragraphs (a) to (e) also apply to the operating compartment and any radio room and centralised machinery control room.

*Note* Annual mean temperatures are available for land locations from the Bureau of Meteorology website.

#### 4.8.5 Lighting

A vessel must have the following:

- (a) lighting in all enclosed accommodation spaces, enabling:
  - (i) free movement around the accommodation space; and
  - (ii) a person to read;
- (b) a means of blocking natural light to sleeping spaces;

#### 4.8.6 Noise and vibration

Accommodation spaces on a vessel must be arranged and equipped to comply with the *Code on Noise Levels On Board Ships*.

#### 4.9 Crew accommodation — source of deemed-to-satisfy solution

Berthed accommodation spaces for crew and special personnel on a vessel must comply with the requirements mentioned in **Table 6**.

**Table 6 — Sources of deemed-to-satisfy solutions for accommodation for crew and special personnel**

Vessel	Class of service:	Class of service:
	1A, 1B, 2A, 2B	1C, 1D, 1E, 2C, 2D, 2E, 3A, 3B, 3C, 3D, 3E
≥3000 GT	MLC 2006 clause 3.1	clauses 4.7 to 4.17
≥35 m measured length and <3000GT	MLC 2006 clause 3.1(1)	clauses 4.7 to 4.17
<35 m measured length	clauses 4.7 to 4.17	clauses 4.7 to 4.17

#### 4.10 Crew sleeping accommodation

##### 4.10.1 Application of clauses 4.10.2 to 4.10.7

Clauses 4.10.2 to 4.10.7 apply to a vessel that has accommodation level AL36-72 or AL72+ and is not subject to MLC 2006 (see clause 4.9).

#### 4.10.2 Location

Sleeping accommodation on a vessel operating at sea must be located to minimise the effects of motion and acceleration.

#### 4.10.3 Dedicated space

Sleeping accommodation must be separate from cargo and storage spaces.

#### 4.10.4 Arrangement

##### 4.10.4.1 Separation from other spaces

Sleeping accommodation must be separated from other spaces on the vessel to prevent or minimise the following:

- (a) movement of persons to other spaces via the accommodation space;
- (b) liquids, odours and fumes entering into the accommodation space from other spaces.

##### 4.10.4.2 Noise

Sleeping accommodation must comply with the *Code on Noise Levels On Board Ships*.

##### 4.10.4.3 Watertight and gastight bulkheads

Bulkheads separating sleeping rooms from cargo holds, fish rooms and machinery spaces must be watertight and gastight.

#### 4.10.5 Openings into sleeping accommodation spaces

Except for emergency escape, there must be no direct openings into sleeping rooms from:

- (a) cargo holds, fish rooms or machinery spaces; and
- (b) on a vessel of at least 35 m measured length — the following:
  - (i) galleys;
  - (ii) storerooms;
  - (iii) drying rooms.

#### 4.10.6 Crew per sleeping room

Sleeping rooms on a vessel must have the following measures:

- (a) the maximum number of crew per sleeping room must not exceed the number mentioned in **Table 7** for the accommodation level and measured length ( $L_m$ ) of the vessel;
- (b) on a vessel assigned accommodation level AL72+, officers must be accommodated in sleeping rooms that are separate from the crew;
- (c) sleeping accommodation must be arranged to provide appropriate levels of privacy for men and for women;
- (d) the maximum number of crew to be accommodated in any sleeping room must be legibly and indelibly marked on the exterior and interior of the sleeping room door.

**Table 7 — Deemed-to-satisfy minimum required for number of crew and floor area per person in sleeping rooms**

Accommodation level	Maximum number of crew per sleeping room	Minimum required deck area per person (m <sup>2</sup> )		
		$L_m \geq 35$ m	$L_m < 35$ m	Total, including communal areas for recreational use, excluding passageways
		Sleeping room	Sleeping room	
AL72+	4	2.0	0.9	2.0
AL36-72	6	1.5	0.7	1.5

**4.10.7 Floor area****4.10.7.1 Adequate space and comfort**

The floor area inside a sleeping room must have adequate space and comfort for the crew occupying the room.

**4.10.7.2 Minimum floor area per person**

The deemed-to-satisfy minimum floor area per person of a sleeping room, excluding space occupied by berths and lockers, must be at least that mentioned in **Table 7** for the accommodation level and measured length ( $L_m$ ) of the vessel.

**4.10.8 Berths****4.10.8.1 Number of berths**

The vessel must have the following for each member of the crew:

- (a) a separate berth;
- (b) a mattress.

**4.10.8.2 Arrangement**

Berths must be located so that a person can reach a berth without disturbing a person occupying another berth.

**4.10.8.3 Material and construction**

The material and construction of a berth and mattress must avoid harbouring vermin and facilitate restful sleep.

**4.10.8.4 Minimum dimension**

The minimum inside dimensions of the berths are at least those mentioned in **Table 8**.

**Table 8 — Deemed-to-satisfy minimum dimensions of sleeping berths**

Minimum berth dimensions inside length (mm) x breadth (mm)	
$L_m \geq 35$ m	$L_m < 35$ m

---

**Minimum berth dimensions inside length (mm) x breadth (mm)**

---

1980 x 800

1900 x 700

**4.10.8.5 Tiers of berths**

Berths may be arranged in tiers if:

- (a) the minimum clear height between decks is at least 1900 mm; and
- (b) a tier has no more than 2 berths; and
- (c) the underside of the mattress of the lower berth is at least 300 mm above the deck; and
- (d) the clear space between the topside of the mattress of the lower berth and the underside of the top berth is at least 635 mm; and
- (e) the upper berth is placed approximately midway between the bottom of the lower berth and the lower side of the deckhead beams; and
- (f) the upper berth has a barrier preventing dust from dropping onto the lower berth.

**4.10.8.6 Fitout**

A sleeping room must have the following:

- (a) separate locker space for each person for clothing and other personal effects;
- (b) for a vessel assigned accommodation level AL72+ — the locker space for each person must have:
  - (i) a suitable locking device; and
  - (ii) a rod for holding clothes on hangers; and
  - (iii) a drawer or equivalent space that is at least 0.06 m<sup>3</sup>;
- (c) a suitable writing surface on a vessel assigned accommodation level AL72+;
- (d) for a vessel more than 35 m measured length assigned accommodation level AL72+ — a writing surface that is a desk, and a chair.

**4.11 Passenger accommodation****4.11.1 Maximum permitted number of passengers having access to a deck**

The maximum number of passengers allowed access to a deck is the least number determined in accordance with the following criteria:

- (a) intact stability in NSCV Part C Subsection 6A;
- (b) buoyancy and stability after flooding in NSCV Part C Subsection 6B;
- (c) minimum clear deck area in clause 4.11.2.1;
- (d) minimum seating in clause 4.11.2.2;
- (e) escape or evacuation mentioned in Chapter 5.

*Note* The total number of passengers may also be limited by the quantity of life-saving equipment fitted to the vessel — see NSCV Part C Subsection 7A.

#### 4.11.2 Spaces for passengers other than sleeping accommodation

##### 4.11.2.1 Clear deck area

###### 4.11.2.1.1 Required minimum clear deck area

Each deck on a passenger-carrying vessel must have a minimum clear deck area per passenger of at least that mentioned in **Table 9**.

**Table 9 — Minimum required clear deck area per passenger**

Class of vessel	Minimum clear deck area in m <sup>2</sup> /passenger	
	Passage time >2 hours	Passage time ≤2 hours
A, B	0.85	N/A
C	0.85	0.55
D	0.55	0.55
E	0.55	0.40

###### 4.11.2.1.2 Available area to include seating

For determining the available clear deck area:

- (a) a person seated must not be deducted from the number of persons used in the calculation; and
- (b) an area for seating must not be deducted from the available area if:
  - (i) the seat allocated to a single person is not of excessive size; and
  - (ii) the number of seats provided does not exceed the number of persons intended to use the space; and
- (c) if fixed seating is fitted at the perimeter of the space, the measurements must be taken from the front surface of the back of the seat; and
- (d) if the area of an individual seat, including 300 mm leg room, exceeds the required area per person mentioned in clause 4.11.2.1, the area exceeding must be deducted from the available clear deck area.

##### 4.11.2.2 Seating accommodation

###### 4.11.2.2.1 Application

A vessel must have seating accommodation as follows:

- (a) for a vessel in operational area A or B — seating provision must be made for each passenger;
- (b) for a vessel in operational area C, D or E — the seating mentioned in **Table 10** is required.

**Table 10 — Minimum required seating accommodation for passengers on vessels in operational areas C, D and E**

Anticipated time on board	Minimum seating as a proportion of total number of passengers (%)		
	Operational area C	Operational area D	Operational area E
≥60 minutes	100%	100%	100%
≥30 and <60 minutes	100%	100%	75%
≥15 and < 30 minutes	100%	75%	40%
<15 minutes	75%	40%	40%

**4.11.2.2.2 Minimum requirements for seats**

Seating for passengers on a vessel must:

- (a) be located in a position:
  - (i) protected from the force of the sea; and
  - (ii) where the likelihood of falling overboard or injury is minimal; and
- (b) unless clause 4.11.2.2.4 applies — not be placed along the collar of a collared vessel; and
- (c) if continuous seating is provided — consist of at least 475 mm of seating for each person; and
- (d) be fixed.

**4.11.2.2.3 Arrangement**

A vessel must have the following seating arrangements:

- (a) for seats arranged in rows facing 1 way — the distance from seat front to seat front must be at least 750 mm;
- (b) aisles forming passageways between banks of fixed seating must at least the widths mentioned in **Table 11**;
- (c) the clearance between rows of fixed seats measured horizontally from the squab of the seat must be at least:
  - (i) 300 mm if the distance from a seat to an aisle is 3.5 m or less; or
  - (ii) 500 mm if the distance from a seat to an aisle is more than 3.5 m.

**Table 11 — Aisles forming passageways between banks of fixed seating**

Number of persons served	Minimum width of aisle (mm)	
	For aisle length ≤4.5 m	>4.5 m
Up to 18	See clause 5.11.2	See clause 5.11.2
18 to 72	600	750
More than 72	750	750



**4.11.2.2.4 Collared vessels carrying divers only**

For a collared vessel carrying divers and operating at speeds up to 25 knots, inclusion of sections of the collar as seating is deemed-to-satisfy if the seating on the collar complies with the following:

- (a) the upper surface of the collar in the way of the seat is at least 400 mm above the cockpit deck;
- (b) the surface of the collar has a slip-resistant surface at the point where each diver is seated with at least 700 mm of collar length for each diver;
- (c) each diver is provided with at least 2 points of attachment to the vessel;
- (d) the points of attachment are arranged to ensure that holding on to the attachments prevents the diver from falling overboard;
- (e) only 1 point of attachment is fixed directly to the collar itself.

*Note* NSCV Part C Subsection 6A also specifies requirements for seating on collared vessels.

**4.11.3 Sleeping accommodation for passengers**

A vessel assigned accommodation level AL72+ or AL36-72 must have the sleeping accommodation for passengers mentioned in **Table 12**.

**Table 12 — Applicable clauses for sleeping accommodation for passengers**

Clause	Description
4.10.3	Dedicated space
4.10.4	Arrangement
4.10.5	Openings into sleeping accommodation spaces
4.10.8.1	Number of berths
4.10.8.3	Material and construction

**4.11.4 Access for persons with disabilities****4.11.4.1 Application**

Clause 4.11.4:

- (a) applies to the following Class 1 vessels:
  - (i) a passenger ferry carrying more than 36 passengers;
  - (ii) a pre-booked public passenger service:
    - (A) carrying more than 100 passengers; and
    - (B) operating in accordance with a publicly available itinerary to a common scenic, tourist, sporting or cultural attraction; and
- (b) does not apply to a water taxi or a vessel engaged in adventure travel.

*Note* The *Disability Discrimination Act 1992* may apply to specific vessels. These provisions may not provide complete compliance with that Act. The provisions that follow make no special provision for escape and evacuation of persons with disabilities. Arrangements for dealing with this matter would normally be addressed by the safety management system — see Marine Order 504.

**4.11.4.2 Extent of access**

Access for persons with disabilities must be arranged:

- (a) to accommodate mobility aids that fit *Disability Standards for Accessible Public Transport Guidelines* (Part 40.1 Assumptions about public transport mobility aids) dimension and performance criteria as reasonably practicable; and
- (b) to facilitate access for embarkation, disembarkation and use of sanitary facilities; and
- (c) to provide reasonable equity with persons without disabilities.

**4.11.4.3 Doorways, passageways and corridors**

A doorway, passageway or corridor used as a path for a person with a disability must have at least 850 mm clear width.

**4.11.4.4 Priority seating**

A vessel must have the following measures for priority seats:

- (a) at least 2 seats reserved as priority seating for passengers with a disability or other passengers in need of special assistance;
- (b) signage stating priority seating must be vacated for a passenger with a disability or a passenger in need of special assistance.

**4.11.4.5 Allocated spaces**

A vessel must have spaces for wheelchairs or other mobility aids as follows:

- (a) for the first 37 passengers — at least 2 spaces;
- (b) for each additional 50 passengers — an additional space;
- (c) for each space:
  - (i) a clear deck area of at least 800 mm by 1300 mm; and
  - (ii) for the deduction for allowable floor area mentioned in clause 4.11.2.1.2 — at least 1.04 m<sup>2</sup> less the minimum clear deck area per person mentioned in clause 4.11.2.1.

**4.11.4.6 Sleeping accommodation**

If a vessel has passenger sleeping accommodation, it must have sleeping berths accessible to persons with disabilities as follows:

- (a) at least 1 berth for the first 32 passengers;
- (b) 1 more berth for each additional 32 passenger berths or fewer.

**4.11.4.7 Sanitary facilities**

A vessel must have the following sanitary facilities:

- (a) if toilets, washbasins or showers are required for the vessel under clause 4.15 — at least 1 sanitary facility suited for the use of a person with a disability;

- 
- (b) if the number of berths or allocated spaces for a person with a disability amounts to threshold values for multiple sanitary facilities in clause 4.15 — multiple facilities;
  - (c) a toilet space with:
    - (i) a minimum dimension of 450 mm from the centre line of the pan to the near-side wall; and
    - (ii) a minimum dimension of 1150 mm from the centre line of the pan to the far-side wall; and
    - (iii) a minimum dimension of 800 mm from the back wall to the front edge of the pan; and
    - (iv) a toilet seat that is 460 mm to 480 mm above the floor; and
    - (v) a grab-rail complying with the requirements for grab-rails in sanitary facilities in *AS 1428.1-2009 — Design for access and mobility — Part 1: General requirements for access — New building work*;
  - (d) washbasins complying with the requirements for washbasins in sanitary facilities in *AS 1428.1-2009 — Design for access and mobility — Part 1: General requirements for access — New building work*.

#### **4.12 Facilities for sick or injured persons**

A vessel must have the following measures for sick or injured persons:

- (a) for a vessel assigned accommodation level AL72+ — at least 1 shared cabin with a space designated for use as a sick bay to separate a sick or injured person from other persons on board;
- (b) for a vessel of operational area A and more than 35 m measured length — a designated sick bay arranged and equipped specifically for the purpose.

#### **4.13 Crew mess facility**

##### **4.13.1 Application**

A vessel assigned accommodation level AL36-72 or AL72+ must have a mess facility for crew.

##### **4.13.2 Size and location**

The mess room must be:

- (a) equipped with tables and seats to accommodate at least two thirds of the crew in any 1 sitting; and
- (b) located close to the galley; and
- (c) if the vessel is assigned accommodation level AL72+ or there are more than 10 crew — separate from sleeping quarters.

**4.13.3 Mess amenities**

A vessel required to fit heating, cooling or both under clause 4.8.4 must have the following:

- (a) if heating is required — facilities for making hot drinks;
- (b) if cooling is required — a refrigerator of sufficient capacity or another means of supplying chilled drinks;
- (c) the facilities must be available and accessible to crew at all times.

**4.13.4 Recreational facilities**

A vessel must have the following recreational facilities:

- (a) mess rooms;
- (b) for a vessel assigned accommodation level AL72+ — amenities that provide all crew with a reasonable opportunity for relaxation.

**4.14 Galley and food storage facilities****4.14.1 Cooking area**

A vessel must have cooking areas as follows:

- (a) for a vessel assigned accommodation level AL72+ or AL36-72 — facilities for preparing and cooking food;
- (b) if a separate galley is not provided, the galley, or cooking area must be of adequate size for the purpose — well lit and ventilated and surfaces must be suited to convenient and effective cleaning.

**4.14.2 Food storage**

A vessel must have the following, sufficient for crew and passengers for the duration of the voyage:

- (a) a suitable place for provisions that can be kept dry, cool and well ventilated to avoid deterioration of the stores;
- (b) a refrigerator or other low temperature storage;
- (c) for a vessel assigned accommodation level AL72+ — a dedicated provisions storeroom and cool-room.

**4.14.3 Wastes**

Waste must be:

- (a) isolated; and
- (b) kept in closed, well-sealed containers that are intended to be removed from foodhandling areas at regular intervals.

## 4.15 Sanitary facilities

### 4.15.1 Requirement to provide toilets and washbasins

A vessel, including a vessel assigned accommodation levels AL12-36, AL36-72 and AL72+ must have toilets and washbasins:

- (a) in accordance with **Table 13**; and
- (b) if required by the table — of the number mentioned in clause 4.15.3.

**Table 13 — Deemed-to-satisfy requirements for fitting of toilets and wash basins on vessels**

Vessel use category	Number of passengers	Threshold passage time before toilet facilities and washbasins required
Class 1	$\geq 37$	15 minutes
	13 to 36	30 minutes
Class 2	1 to 12	2 hours
	0	12 hours
Class 3	0	12 hours

### 4.15.2 Requirement to provide showers or baths

A vessel assigned accommodation level AL36-72 or AL72+ must have showers or baths for the use of all persons berthed onboard in accordance with clause 4.15.3.

### 4.15.3 Minimum number of sanitary facilities

For a vessel required to have sanitary facilities under clauses 4.15.1 and 4.15.1, the minimum required deemed-to-satisfy number of toilets, washbasins and showers or baths is the number mentioned in **Table 14**.

**Table 14 — Deemed-to-satisfy requirements for the minimum required number of toilets, washbasins and showers or baths on vessels**

Type of accommodation	Toilets	Washbasins	Showers or baths
	clause 4.15.1	clause 4.15.1	clause 4.15.1
Berthed AL72+	1 for every 6 persons or fewer	1 for every 6 persons or fewer	1 for every 6 persons or fewer
Berthed AL36-72	1 for every 8 persons or fewer	1 for every 6 persons or fewer	1 for every 8 persons or fewer
Berthed AL12-36	1 for every 15 persons or fewer	1 for every 15 persons or fewer	Not required

Type of accommodation	Toilets	Washbasins	Showers or baths
	clause 4.15.1	clause 4.15.1	clause 4.15.1
Unberthed: Passage time 1 hour or more and 100 persons or less	1 for every 50 persons or fewer	1 for every 50 persons or fewer	Not required
Unberthed: Passage time 1 hour or more and more than 100 persons	For 101 persons — 3 For each additional 100 persons — 1 more	For 101 persons — 3 For each additional 200 persons — 1 more	Not required
Unberthed: Passage time less than 1 hour and 150 persons or less	1	1	Not required
Unberthed: Passage time less than 1 hour and more than 150 persons	For 151 persons — 2 For each additional 150 persons — 1 more	For 151 persons — 2 For each additional 200 persons — 1 more	Not required

#### 4.15.4 Hygiene

A vessel must have the following hygiene measures:

- (a) for berthed persons — fresh water, both hot and cold, at each washbasin, shower and bath;
- (b) for unberthed persons — cold freshwater at each washbasin;
- (c) toilets with ample flush of water, available at all times and independently controllable;
- (d) hygeine bins situated in toilet facilities for disposal of female sanitary products;
- (e) sanitary facilities and the spaces containing them arranged to prevent contamination of other spaces;
- (f) all surfaces in sanitary spaces to facilitate easy and effective cleaning;
- (g) floors with a slip-resistant deck covering;
- (h) sanitary facilities fitted with ventilation;
- (i) ventilation to the outside, independent of any other part of the accommodation.

**4.15.5 Privacy**

Sanitary facilities must have privacy.

**4.16 Crew cloak and laundry facilities**

A vessel must have the following measures for crew cloak and laundry facilities:

- (a) a place for the crew to hang foul-weather gear and other personal protective equipment outside, but convenient to, sleeping rooms;
- (b) for a vessel assigned accommodation level AL72+ — adequate facilities for the crew to wash, dry and iron clothes;
- (c) if the vessel is at least 35 m measured length:
  - (i) facilities for washing, drying and ironing clothes in a compartment separate from sleeping rooms, mess rooms and toilets;
  - (ii) adequate ventilation and heating, and lines or other means of drying clothes.

**4.17 Potable water****4.17.1 Requirement for potable water**

A vessel must have, for drinking and hygiene purposes:

- (a) in each wash place:
  - (i) cold potable water; and
  - (ii) either hot potable water or a means of heating water; and
- (b) for the normal duration of a voyage — at least the amount of potable water mentioned in **Table 15**.

**Table 15— Minimum amount of potable water**

Assigned accommodation level	Minimum amount of potable water per person per day or part day(L)
AL72+	60
AL36-72	60
AL12-36	20
AL<12	5

**4.17.2 Limited application to AL<12 vessels**

Table 15 applies to an AL<12 vessel only if it provides a ferry service and is fitted with a toilet.

#### 4.17.3 Arrangement of tanks

A vessel fitted with potable water tanks must comply with the following requirements:

- (a) tanks for potable water must have no common boundary with other tanks on board containing liquids, if contamination by those liquids could have serious health consequences for persons on board;
- (b) tanks for potable water must be labelled “Potable Water”;
- (b) to facilitate periodic inspection and cleaning, tanks for potable water must be accessible through a watertight manhole or, if sufficient, a watertight hand hole, and must be completely drainable from a bottom drain.

## Chapter 5 Access, escapes and evacuation

### 5.1 Scope

This Chapter specifies minimum requirements for the location, arrangement, type, size and details of arrangements for access, escape and evacuation on vessels.

### 5.2 Definitions

In this Chapter:

*rung* means the step of a rung ladder or step on the vertical surface.

*stringer* means the frame of a ladder.

*tread* means the step of a step ladder.

### Required outcomes

#### 5.3 Required outcome — escape from hazards within spaces on the vessel

Enclosed spaces on a vessel must have escape routes of sufficient number and size to eliminate or reduce to acceptable levels the exposure of persons on board the vessel to hazards such as fire, smoke, and flooding.

#### 5.4 Required outcome — redundancy in escapes

Alternative escape routes on a vessel must control the risk of entrapment from the blocking of a single escape, having regard to the magnitude of risk if the escape route is blocked (eg the likelihood and consequences of exposure to hazards).

#### 5.5 Required outcome — facilitate movement for evacuation

A vessel must be designed, constructed and furnished to facilitate in an emergency the orderly and timely movement of persons to:

- (a) places of assembly; and
- (b) disembarkation points for evacuation into survival craft.



**5.6 Required outcome — facilitate movement between decks**

Means of access between different deck levels on the vessel must be designed and constructed to facilitate the rapid movement of persons in an emergency and to avoid tripping hazards.

**5.7 Required outcome — accommodate the needs of a large proportion of the population**

Means of escape must be designed to accommodate at least a 95 percentile range of potential users, assuming users are wearing lifejackets of the type required to be provided on board the vessel.

**Deemed-to-satisfy solutions****5.8 Escape from spaces****5.8.1 Accessways to provide viable means of escape**

The primary access to an enclosed space accessible to persons on a vessel must be arranged to provide a ready means of escape if there is a hazard within the space.

**5.8.2 Alternative means of escape****5.8.2.1 General requirement**

Unless stated otherwise in clause 5.8.2.7, all levels of accommodation and all operational workspaces must have an alternative means of escape, in a location widely separated from the primary point of access.

**5.8.2.2 Spaces below the bulkhead deck**

If the space mentioned in clause 5.8.2.1 is below the bulkhead deck, at least 1 means of escape must not rely on passage through a watertight door.

**5.8.2.3 Spaces on decks above the bulkhead deck**

A vessel must have spaces on deck above the bulkhead deck as follows:

- (a) if the space mentioned in clause 5.8.2.1 lies on a deck above the bulkhead deck, at least 1 escape must give access to a stairway or ladder forming a vertical escape;
- (b) if the space contains less than 12 persons, the alternate means of escape may be a stairway, a ladder or a door to an open deck.

**5.8.2.4 Prohibition on escapes leading into the same high fire risk category space**

An escape route from a high fire risk space must not be through another high fire risk space.

**5.8.2.5 Control spaces**

Control spaces on a vessel must comply with the following requirements for escape routes:

- (a) an enclosed control space occupied for extended periods during an emergency (eg the operating compartment, machinery control rooms or

compartments containing emergency steering gear) must have an alternative means of escape, unless configured in accordance with clause 5.8.2.7;

- (b) at least 1 of the means of escape must be to a space different from that accessed by other escapes from the control space.

#### **5.8.2.6 Ro-Ro spaces**

##### **5.8.2.6.1 Minimum requirement for all ro-ro spaces**

A vessel with a ro-ro space must have the following:

- (a) at least 2 means of escape from each end of the ro-ro space:
  - (i) 2 means of escape at the fore end; and
  - (ii) 2 means of escape at the aft end;
- (b) escape routes with safe access to an evacuation path.

##### **5.8.2.6.2 Passenger access**

If passengers have access to ro-ro spaces escapes additional to those mentioned in clause 5.8.2.6.1 must be provided so that the distance from any point within the ro-ro space to an escape does not exceed 30 metres.

#### **5.8.2.7 Spaces not required to have an alternative means of escape**

A space that complies with **Table 16** does not need to have 2 separate means of escape.

**Table 16 — Spaces not required to have an alternative means of escape**

<b>Type of space</b>	<b>Conditions</b>
Accommodation space	<ul style="list-style-type: none"> <li>(a) the space does not accommodate more than 6 passengers or more than 8 persons in total;</li> <li>(b) the single means of escape is not through a watertight door;</li> <li>(c) the maximum actual horizontal travel distance to the point of escape does not exceed 5 m for passenger accommodation or 7 m for accommodation for crew only;</li> <li>(d) The single means of escape does not lead to a space that does not itself have direct access to open decks;</li> <li>(e) the space is not also of moderate fire risk (containing a small galley or a moderate fire risk machinery space);</li> <li>(f) the single means of escape does not lead to a space classified as high fire risk or moderate fire risk</li> </ul>

Type of space	Conditions
High fire risk machinery space arranged for unmanned operation, dedicated moderate fire risk machinery space or galley	<ul style="list-style-type: none"> <li>(a) the maximum actual horizontal travel distance to the point of escape does not exceed 5 m;</li> <li>(b) the single means of escape is not through a watertight door;</li> <li>(c) the single means of escape does not lead to a space that does not itself have direct access to open decks;</li> <li>(d) the single means of escape does not lead to a space classified as high fire risk or moderate fire risk</li> </ul>
Space of low fire risk	<ul style="list-style-type: none"> <li>(a) it is only entered by crew;</li> <li>(b) it is only occupied occasionally</li> </ul>

#### **5.8.2.7.1 Design of dead-end corridors**

A dead-end corridor must be arranged and marked to deter a person from entering the corridor in an emergency.

### **5.8.3 Type, number and size of escapes serving a space**

#### **5.8.3.1 Types of escapes to be appropriate**

##### **5.8.3.1.1 Suitability of escapes**

The design of an escape must take into account:

- (a) the number of persons who may need to use it; and
- (b) whether it is to be used by passengers or by crew.

##### **5.8.3.1.2 Requirements for escapes**

The escapes for each space must comply with **Table 17** or **Table 18**.

#### **5.8.3.2 Unsuitable means of escape**

The following are not means of escape:

- (a) a lift;
- (b) unless it has a viable evacuation path to the survival craft embarkation deck or an assembly area — the following spaces:
  - (i) an accessway;
  - (ii) a balcony.

**Table 17 — Types of escapes from accommodation spaces**

<b>Nominal number of persons within the space</b> (sum of number of passengers and 2/3 number of crew)	<b>Primary access</b>	<b>Alternative escapes</b>
0 to 4	Low capacity acceptable, rung ladders limited to use by crew only and not more than 1.5 m high	Low capacity acceptable
5 to 12	Low capacity door, stairway, passageway or walkway acceptable (but not rung ladder), step ladders limited to not more than 1.5 m high	Low capacity acceptable
13 to 72	High capacity	Single high capacity, or low capacity counted at 18 persons each
>72	High capacity	High capacity and up to 4 low capacity counted at 18 persons each

*Note* Nominal number of persons is the sum of the number of passengers and 2/3 the number of crew, given that at any time, 2/3 of the crew will be resting.

**Table 18 – Types of escapes from workspaces**

<b>Number of crew normally in the space</b>	<b>Primary access</b>	<b>Alternative escapes</b>
0 to 4	Low capacity acceptable, rung ladders limited to not more than 6 m high	Low capacity acceptable Rung ladders limited to not more than 6 m high
5 to 12	Low capacity door, stairway, passageway or walkway acceptable, rung ladders not permitted	Low capacity acceptable Rung ladders limited to not more than 6 m high
≥13	High capacity	High capacity; or low capacity counted at 18 persons each

### **5.8.3.3 High capacity escapes**

A high capacity escape access must comply with **Table 19**.

**Table 19 — Minimum criteria for high capacity escapes**

<b>Type of space</b>	<b>Passenger spaces</b>	<b>Crew spaces</b>
Corridor or passageway	Minimum width 900 mm if vessel carries >36 pax Minimum width 700 mm otherwise Sized in accordance with Annex A	Minimum width 700 mm Sized in accordance with Annex A
Door way	Minimum width 900 mm if vessel carries >36 pax Minimum width 700 mm otherwise Sized in accordance with Annex A	Minimum clear width 700 mm Sized in accordance with Annex A
Stairway	Minimum width 900 mm if vessel carries >36 pax Minimum width 700 mm otherwise Sized in accordance with Annex A Treads in accordance with clause 5.13.3.4 Slope in accordance with clause 5.13.2 Width of hatches associated with stairways in accordance with Annex A	Minimum width 700 mm Sized in accordance with Annex A Treads in accordance with clause 5.13.3.4 Slope in accordance with clause 5.13.2 Width of hatches associated with stairways in accordance with Annex A
Ladder	Not considered a high capacity escape	Not considered a high capacity escape
Escape hatch	Not considered a high capacity escape	Not considered a high capacity escape
Walkway	Minimum width 900 mm if vessel carries >36 pax Minimum width 700 mm otherwise Sized in accordance with Annex A Slope — see preferred slope in clause 5.13.2	Minimum clear width 700 mm Sized in accordance with Annex A Slope — see clause 5.13.2

**5.8.3.4 Low capacity escapes**

A low capacity escape access must comply with **Table 20**.

**Table 20 — Minimum criteria for low capacity escapes**

<b>Type of space</b>	<b>Passenger spaces</b>	<b>Crew spaces</b>
Corridor	Minimum clear width 650 mm	Minimum clear width 600 mm
Passageway	Minimum width — see clause 5.11.2	Minimum width — see clause 5.11.2
Doorway, vertical escape hatch, popout window, breakable window	Minimum dimensions in accordance with clause 5.10.5	Minimum dimension in accordance with clause 5.10.5
Stairway	Minimum clear width 650 mm Treads in accordance with clause 5.13.3 Slope in accordance with clause 5.13.2	Minimum clear width 600 mm Treads in accordance with Slope in accordance with clause 5.13.2
Ladder	Step ladders of height greater than 1.5 m applicable only if direction of flow is upward. Minimum width clause 5.13.4.1 Treads in accordance with clause 5.13.4.1 Slope in accordance with clause 5.13.2	Minimum width clause 5.13.4.1 Treads in accordance with clause 5.13.4.1 Slope in accordance with clause 5.13.2
Horizontal escape hatch	Minimum 460 mm x 460 mm Maximum height 1.2 m before ladder	Minimum 460 mm x 460 mm Maximum 1.2 m before ladder
Walkway	Minimum clear width 650 mm Slope — see clause 5.13.2	Minimum clear width 600 mm Slope — see clause 5.13.2

**5.8.4 Arrangement of escapes in accommodation spaces**

An escape path must:

- (a) be as direct as possible; and

- (b) have a minimum number of changes in direction.

## 5.9 Evacuation paths

### 5.9.1 General requirement

A vessel must have evacuation paths allowing the ready and rapid movement of persons from every normally occupied space on the vessel, through assembly stations if required by clause 5.9.5.1, to the survival craft embarkation stations.

### 5.9.2 Size of evacuation path

An evacuation path must comply with the size requirements of **Table 21**.

### 5.9.3 Special provisions for passenger vessels

At least 1 of the evacuation paths from each passenger space must be arranged to enable a person to reach an assembly station or open deck without having to climb more than 2 decks up or down.

### 5.9.4 Evacuation analysis

For a vessel that carries more than 36 passengers and is at least 90 m measured length:

- (a) the arrangements for evacuation paths must be evaluated by an evacuation analysis early in the design process; and
- (b) the analysis must:
  - (i) identify and eliminate, to the extent practicable, congestion during an abandonment from the movement of passengers and crew along escape routes, including crew moving along the routes in a direction opposite the movement of passengers; and
  - (ii) demonstrate that arrangements are sufficiently flexible if certain evacuation paths, assembly stations, embarkation stations or survival craft are unavailable because of a casualty.

**Table 21 — Size of evacuation paths**

Description of path	Determination of size		Minimum width
	Along path	At end of path	
To a survival craft embarkation station without an assembly station	Cumulative number of persons, taking into account size of adjacent spaces, additional persons from adjoining spaces, percentage persons through the particular escape	Combined capacity of survival craft at the embarkation station	700 mm
To an assembly station	Cumulative number of persons entering into the path leading to the assembly	Proportion of total number of persons assigned to the	900 mm

Description of path	Determination of size		Minimum width
	Along path	At end of path	
	station, taking into account additional persons from adjoining spaces, percentage persons through the particular escape	assembly station that would enter along that evacuation path	
Between an assembly station and a survival craft embarkation station	Maximum capacity of the largest survival craft served by the assembly station	Maximum capacity of the largest survival craft served by the assembly station	900 mm

### 5.9.5 Assembly stations

#### 5.9.5.1 Application

The evacuation path on the following vessels must include at least 1 designated assembly station:

- (a) a vessel carrying 36 or more passengers;
- (b) a vessel of more than 35 m measured length.

#### 5.9.5.2 Location

Assembly stations must be located close to the embarkation stations.

#### 5.9.5.3 Size of assembly stations

An assembly station must have:

- (a) adequate deck area for the expected number of persons; and
- (b) at least 0.35 m<sup>2</sup> per person clear deck space to accommodate all persons assigned to it.

### 5.9.6 Survival craft embarkation stations

#### 5.9.6.1 Number and arrangement

The number and arrangement of embarkation stations must be sufficient to ensure the launching of all survival craft with their maximum allowable number of persons on board within 30 minutes after the abandon ship signal is given.

#### 5.9.6.2 Deck area

An embarkation area must accommodate the number of persons expected to use the area.

#### 5.9.6.3 Means for embarkation

A vessel must have the following means of embarkation:

- (a) an embarkation ladder or other means of enabling the embarkation of persons into survival craft at each embarkation station to achieve the time mentioned in clause 5.9.6.1;



- (b) the arrangements for embarkation must remain effective when the vessel is in the lightest seagoing condition under unfavourable conditions of trim of up to 10° and a list of up to 20° either way;
- (c) if it complies with clause 5.9.6.1 — means for embarkation into survival craft need not be provided at the embarkation station on a vessel having a freeboard between the intended embarkation station and the waterline in the worst condition of loading, trim and heel of not more than 1.5 m.

## **5.10 Doors and hatches in escape or evacuation routes**

### **5.10.1 Direction of opening**

A door in an escape or evacuation route:

- (a) for a door of an individual cabin — may open into the cabin; and
- (b) for a door in a stair tower — may open out of the tower; and
- (c) in any other case — must open in the direction of escape or evacuation.

### **5.10.2 Normally locked doors and hatches**

Doors or hatches on a vessel must:

- (a) for a door or hatch in an escape route or a designated evacuation path — unlock automatically in the direction of escape or evacuation; and
- (b) for a door to a cabin — unlock without a key from inside the room.

### **5.10.3 Securing of escape and evacuation routes when the vessel is unmanned**

A vessel must have the following:

- (a) means of preventing the unauthorised access of persons onto the vessel when it is unmanned that do not compromise the effectiveness of escape and evacuation routes, other than a primary access door;
- (b) locking mechanisms located to allow rapid and reliable release in the direction of escape or evacuation without the need for a key or special tool;
- (c) arrangements to ensure covers of escape and evacuation openings are operable from both sides when the vessel is manned.

### **5.10.4 Quick release devices on large doors that are normally latched**

A door that provides high capacity escape from public spaces for 110 persons or more (ie of width exceeding 1200 mm) that is normally latched must have a quick release mechanism in the direction of escape that may be activated by:

- (a) a panic bar; or
- (b) a mechanism for rapid and reliable release by a single person.

### **5.10.5 Minimum size of doorways forming alternative escape routes**

A doorway from an alternative escape route must be of a height and size mentioned in **Table 22**.

**Table 22 — Minimum size of doorways forming alternative escape routes**

Maximum number of persons intended to pass through	Minimum height (mm)	Minimum width (mm)
25	1220	815
20	1220	610
15	1120	510
10	915	510
5	660	485

## 5.11 Passageways

### 5.11.1 Passageways serving as evacuation paths

A passageway on an evacuation path must be sized in accordance with clause 5.9.

### 5.11.2 Passageways that serve as means of escape

#### 5.11.2.1 Application

A passageway in an accommodation space or operational space must be arranged to facilitate the rapid movement of persons to the evacuation path.

#### 5.11.2.2 Minimum width of passageways other than corridors

The width of a passageway used for low capacity access and escape must comply with **Table 23**.

**Table 23 — Minimum width of passageways between furniture or fittings**

Length of passageway (m)	Numbers of persons served by the passageway	Minimum width of passageway for single direction flows (mm)	
		Less than 640 mm from the floor (A in Figure 5)	640 mm or more from the floor (B in Figure 5)
≥4.5 m	1 to 5	380	510
	6 to 10	510	600
	11 to 18	600	700
<4.5 m	1 to 5	305	510
	6 to 10	380	510
	11 to 18	510	600

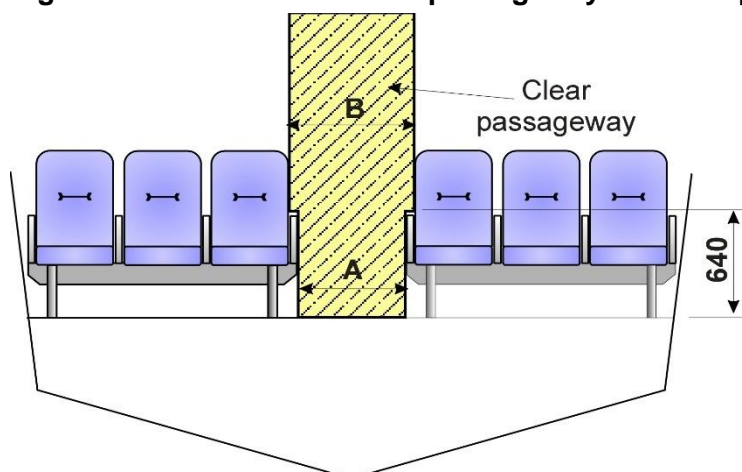
**Figure 5 — Minimum width of passageways for escape routes****5.11.3 Passageways in a ro-ro space that a passenger can access**

A passageway in a ro-ro space that a passenger can access must:

- (a) be permanently marked to prevent obstruction by vehicles; and
- (b) have a clear width of at least 600 mm.

**5.11.4 Accessways that serve only as a means for occasional access**

An accessway used only for occasional access by the crew on inspection or maintenance need not comply with clause 5.11.2.

**5.12 Handrails****5.12.1 Application**

A handrail or other handhold must be provided:

- (a) for each walkway, stairway and ladder; and
- (b) along an evacuation route facilitating persons to move quickly to assembly stations and embarkation stations if the deck is at an angle.

**5.12.2 Minimum distance of and height for handrails along high capacity routes**

A handrail along a high capacity route must be located within 5% of:

- (a) 50 mm clear of the adjacent bulkhead; and
- (b) 865 mm above the upper surface of:
  - (i) the deck, or
  - (ii) the nosing of a stair tread.

**5.12.3 Pairs of handrails**

Handrails must be provided on both sides in the following locations:

- (a) longitudinal corridors and walkways more than 1800 mm in clear width;
- (b) transverse corridors and walkways more than 1000 m in clear width;
- (c) ladders and stairways.

#### 5.12.4 Strength of handrails

Handrails and other handholds and their means of attachment must be designed to withstand the following loads:

- (a) a distributed horizontal load of 750 N/m applied in the direction of the centre of the corridor or space; and
- (b) a distributed vertical load of 750 N/m applied in the downward direction.

### 5.13 Walkways, stairways and ladders

#### 5.13.1 Application

A walkway, stairway or ladder must be provided if:

- (a) the difference in height between 2 levels exceeds 750 mm; and
- (b) persons are likely to need to move between the 2 levels.

#### 5.13.2 Limitations on angles of walkways, stairways and ladders

For this Part:

- (a) the angle of a walkway, stairway or ladder must be within the range mentioned in column 2 of **Table 24**; and
- (b) the angle of a walkway or stairway used as a high capacity escape must be within the range mentioned in column 3 of **Table 24**.

**Table 24 — Angles to the horizontal of walkways, stairways and ladders and limits on their application (see also Figure 6)**

Description	Range of angles to horizontal (degrees)	Range of angles to horizontal for high capacity escape (degrees)	Preferred angle to horizontal (degrees)
Walkway	0 to 20	0 to 10	0 to 10
Stairway	20 to 45	30 to 45	30 to 38
Step ladder	60 to 70	Not applicable	60 to 70
Rung Ladder	70 to 90	Not applicable	70 to 75

**Figure 6 — Angles to the horizontal of stairways, walkways and ladders and limits on their application (see also Table 24)**

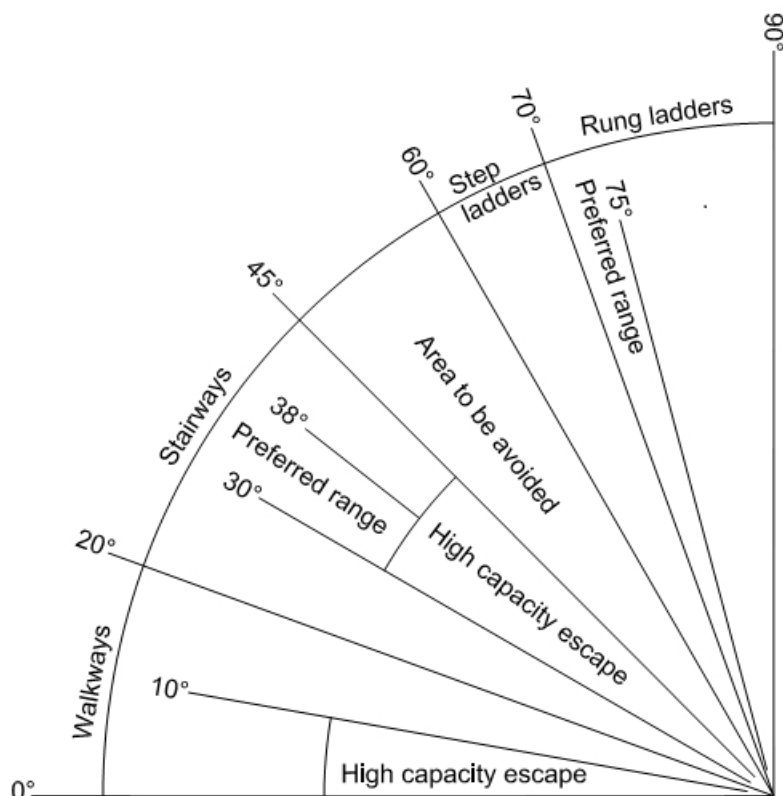

### 5.13.3 Details of stairways

#### 5.13.3.1 Alignment of stairways

A stairway sized for more than 90 persons must be aligned fore and aft.

#### 5.13.3.2 Vertical rise

A stairway must not exceed 3.5 m in vertical rise without an intermediate landing.

#### 5.13.3.3 Landings

If required by clause 5.13.3.2, a landing must:

- be at least 2 m<sup>2</sup> in area; and
- increase by 1 m<sup>2</sup> for every 10 persons provided for in excess of 20 persons; and
- not exceed 16 m<sup>2</sup>.

#### 5.13.3.4 Step dimensions

Steps forming a stairway must:

- be as mentioned in columns 2 and 3 of **Table 25** for the characteristics as illustrated in **Figure 7**; and
- have a constant rise; and

- (c) be within the tolerance range permitted by AS 1657-1992 — *Fixed platforms, walkways, stairways and ladders — Design, construction and installation*.

**Table 25 — Dimensions of steps in stairways**

Characteristic	Steps for high capacity escapes (mm)	Steps for low capacity escapes (mm)	Preferred values (mm)
Rise (R)	115 to 205	$\leq 230$	190
Going (G)	240 to 355	$\geq 150$	275
R to G relationship	$550 \leq (2R + G) \leq 700$	$550 \leq (2R + G) \leq 700$	$600 \leq (2R + G) \leq 660$
Overlap on tread	$\geq 25$ if $G < 254$ 0 if $G \geq 254$		

**Figure 7 — Dimensions of steps in stairways**

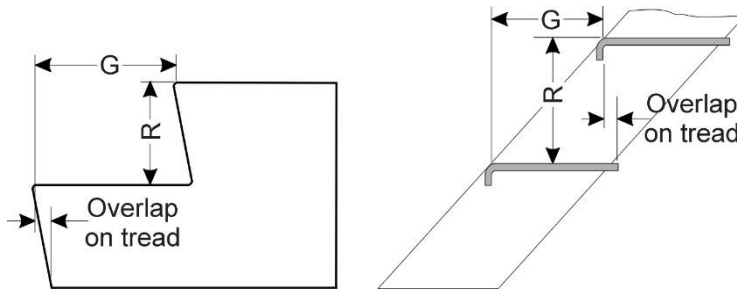

#### 5.13.3.5 Minimum clear height above stairways

The clear height above the top of each stair that forms a stairway must be at least 2 m.

#### 5.13.3.6 Spiral stairways

##### 5.13.3.6.1 Application of Table 17

For **Table 17**, a spiral stairway must comply with the same requirements as a step ladder.

##### 5.13.3.6.2 Internal diameter

Spiral stairways having an internal diameter less than 2440 mm must not be used for high capacity escapes.

##### 5.13.3.6.3 Tapered treads

Tapered treads forming winders and spiral stairways must comply with **Table 25** assuming the going is measured at the following point:

- for a tread up to 1 m wide — the middle of the unobstructed width of the stair (see **Figure 8a**);
- for a tread more than 1 m wide — 400 mm from the unobstructed width of each side of the stair (see **Figure 8b**).

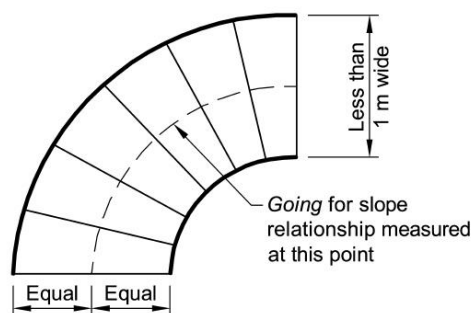
**Figure 8 — Tapered treads****Figure 8 a)**

**Tapered treads — 1 m or more in width**

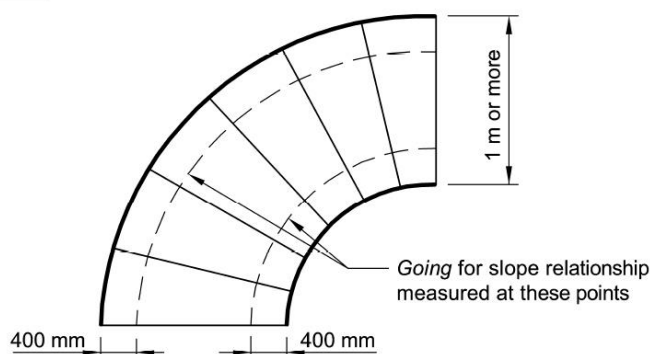
**Figure 8 b)**

#### 5.13.3.7 Construction

A stairway must be designed and constructed to withstand a vertical pressure that is within the range of the design pressure applicable to the decks connected by the stairway.

#### 5.13.3.8 Handrails

Handrails must be fitted in accordance with **Table 26**.

**Table 26 — Handrails**

Stairway	Handrail to be fitted
Stairways forming part of a low capacity escape route	(a) A handrail on at least 1 side in accordance with clause 5.12; or (b) If the height of the stairway is less than 1.5 m — suitable hand holds for use in either direction of travel
Stairways forming part of a high capacity escape	Handrails on both sides in accordance with clause 5.12
Stairways with more than 1800 mm clear width between handrails	Intermediate hand rails spaced not more than 1800 mm apart

### 5.13.4 Details of ladders including step ladders

#### 5.13.4.1 Dimensions

A ladder must meet the following dimensional requirements:

- (a) the width between stringers must be at least 400 mm (see **Figure 9**);

- (b) treads or rungs must be equally spaced except that the height to the lowest tread may be reduced by up to 15%;
- (c) Treads or rungs must be spaced between 200 mm and 300 mm apart, measured vertically (see **Figure 9**).

#### 5.13.4.2 Minimum going on step ladders

The treads of a step ladder must have a going of at least 100 mm (see **Figure 9**).

#### 5.13.4.3 Clearance

The horizontal distance between each tread or rung of a ladder and an adjacent bulkhead must be at least 200 mm.

#### 5.13.4.4 Vertical rise

A ladder must not exceed 6 m in vertical rise without a landing.

#### 5.13.4.5 Construction

A ladder or handrail must be constructed as follows:

- (a) it must be able to withstand a vertical concentrated loading of at least 1 kN;
- (b) it must be constructed of material of adequate strength and stiffness and securely attached to the structure by stays;
- (c) the treads must be securely and permanently secured to the stringers;
- (d) if its stringers are flexible steel wire ropes — it cannot be constructed as an escape route;
- (e) the method of support and length of stays must reduce vibration to a practical minimum.

#### 5.13.4.6 Skew of ladder

A rung ladder must not be skewed by more than  $2^\circ$  (see **Figure 9**).

**Figure 9 — Ladder details**

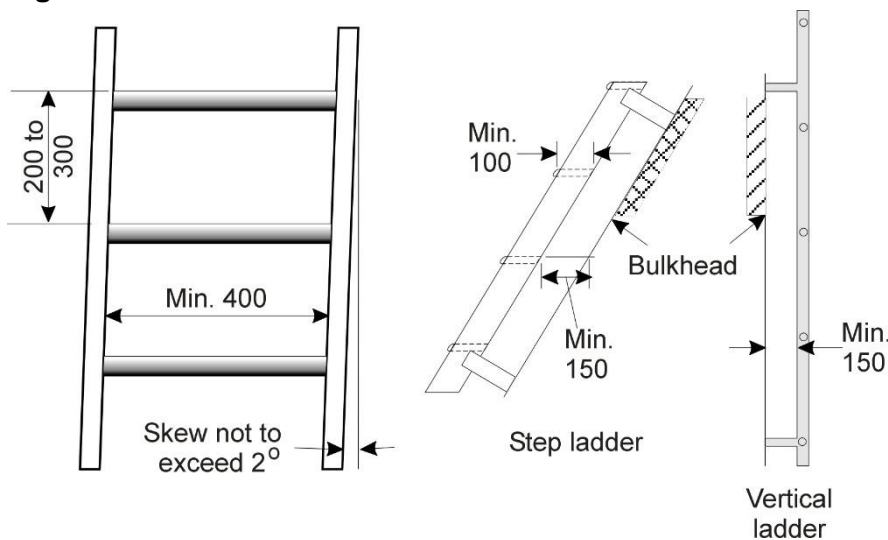

#### 5.13.4.7 Handrails

A step ladder must have handrails of substantial construction on both sides in accordance with clause 5.12, fitted at a convenient distance above the treads.



**5.13.4.8 Cargo holds**

A ladder in a cargo hold must be designed and arranged so that the risk of damage from cargo handling gear is minimised.

**5.14 Safety information****5.14.1 Marking of maximum passengers on each deck****5.14.1.1 Signage**

The number of passengers permitted in a space must be indicated on signage placed in that space.

**5.14.1.2 Application**

Clause 5.14.1.1 applies to a vessel carrying more than 12 berthed persons, or 36 or more passengers

**5.14.2 Marking of escape and evacuation routes****5.14.2.1 Marking of key locations to facilitate escape and evacuation**

The following locations must be clearly and permanently marked unless their location is obvious in daylight, at night and, if applicable under clause 5.14.2.3.1, in conditions of smoke:

- (a) escapes from enclosed spaces intended to contain more than 12 berthed persons, or 36 or more passengers;
- (b) assembly stations if required by clause 5.9.5.1;
- (c) entrances to evacuation routes;
- (d) embarkation points.

**5.14.2.2 Marking of escape paths and evacuation routes****5.14.2.2.1 Marking with strip indicators**

For a vessel that carries more than 36 berthed passengers and is not fitted with emergency lighting complying with Part C Subsection 5B, the following spaces must be marked by strip indicators:

- (a) an escape route from an accommodation space;
- (b) a route to an assembly station;
- (c) an evacuation route to an embarkation point.

**5.14.2.2.2 Installation of strip indicators**

Strip indicators must be installed as follows:

- (a) the indicators must be placed not more than 300 mm above the deck at all points of the route including angles and intersections;
- (b) if power operated, the indicators must be arranged so that a failure of any single light or cut in a lighting strip will not result in the marking being ineffective.

**5.14.2.3 Performance****5.14.2.3.1 Vessels carrying more than 36 berthed passengers**

Markings mentioned in clauses 5.14.2.1 and 5.14.2.2 on a vessel carrying more than 36 passengers must be visible:

- (a) by day; and
- (b) by night; and
- (c) in smoke-filled conditions.

**5.14.2.3.2 Vessels not carrying more than 36 berthed passengers**

For other vessels subject to clauses 5.14.2.1 and 5.14.2.2, the markings need only be visible by day or by night.

**5.14.2.3.3 Illumination**

The deemed-to-satisfy arrangements for marking in conditions of reduced visibility are in accordance with **Table 27**.

**Table 27 — Deemed to satisfy arrangements for marking in conditions of reduced visibility**

Type of marking	Suitable for night and conditions of smoke	Suitable for night
Self-illuminated marking supplied by a central emergency power source	Applicable	Applicable
Self-illuminated marking supplied by a self contained emergency power source	Applicable	Applicable
Photoluminescent marking	Applicable	Applicable
Marking illuminated by light reflected from a light source for general illumination that is also supplied by the emergency electrical system	Not applicable	Applicable except for strip indicators

**5.14.2.3.4 Minimum duration of operation**

Markings must remain visible for at least the greater of:

- (a) the time mentioned for emergency lighting in Part C Subsection 5B; or
- (b) 2 hours.

**5.14.2.3.5 Standards for design and manufacture**

Markings for escape and evacuation must comply with the *Fire Safety Systems Code*.

**5.14.3 Instruction for safe escape****5.14.3.1 Application**

Clause 5.14.3 applies to a vessel:

- (a) carrying at least 12 berthed passengers; or

- (b) carrying at least 36 day passengers; or
- (c) of at least 25 m measured length.

#### **5.14.3.2 Identification of decks**

On a vessel with 4 or more deck levels:

- (a) each deck must be sequentially numbered, starting with '1' at the tank top or lowest deck; and
- (b) the numbers must be prominently displayed at stair landings and lift lobbies.

#### **5.14.3.3 Directions for rapid escape and evacuation**

A vessel must have directions for rapid escape and evacuation as follows:

- (a) simple 'mimic' plans, showing the 'you are here' position and escape routes marked by arrows, must be prominently displayed on the inside of each cabin door of berthed accommodation and in public spaces;
- (b) the plan must be properly oriented in relation to its position on the vessel showing:
  - (i) the directions of escape; and
  - (ii) the location of primary and any secondary means of escape; and
  - (iii) the number of the crew and passengers normally occupied within the space; and
  - (iv) the location of the relevant assembly stations and survival craft embarkation positions.

## **Chapter 6 Personal safety**

### **6.1 Scope**

This Chapter provides minimum requirements for aspects of a vessel's design relating to personal safety.

### **Required outcomes**

#### **6.2 Required outcome — Safe conduct of operations — lighting**

A vessel must be lit so that all operations can be conducted safely.

#### **6.3 Protection of persons from the elements**

##### **6.3.1 Required outcome — protection from the sea**

A vessel must be arranged to eliminate or reduce to acceptable levels the risk to persons from being physically injured because of exposure to seas that might come onto the deck of the vessel.

**6.3.2 Required outcome — protection from the weather**

A vessel must be arranged to minimise the adverse health and fatigue effects on persons that arise from being exposed for extended periods to extremes of weather.

**6.4 Bulwarks and guard rails****6.4.1 Required outcome — prevention of persons falling overboard including falling over a bulwark or guard rail**

A vessel must be provided with arrangements that eliminate or reduce to acceptable levels the risk of persons falling overboard taking into account the competence and physical characteristics of the persons.

**6.4.2 Required outcome — prevention of persons falling from heights on a vessel including falling over a bulwark or guard rail**

A vessel must be provided with arrangements that eliminate or reduce to acceptable levels the risk of a person falling from elevated locations taking into account the competence and physical characteristics of a person.

**6.4.3 Required outcome — prevention of persons falling by passing through a bulwark or guard rail**

The arrangements must be capable of preventing a person lying on the deck from falling (either overboard or from elevated locations) due to seas on deck, excessive deck angles or excessive accelerations.

**6.5 Required outcome — protection from machinery**

Means must be provided to eliminate or reduce to acceptable levels the risks to persons from hazards arising from machinery operating on the vessel.

**6.6 Required outcome — protection from slip and fall hazards**

A vessel must be provided with measures to eliminate or reduce to acceptable levels the risks associated with fall and slip hazards.

**6.7 Required outcome — protection from hearing damage**

A vessel must be provided with measures to eliminate or reduce to acceptable levels the risk of hearing damage.

**6.8 Required outcome — safe access to and from vessels****6.8.1 Access between a vessel and wharf, pier or landing**

A vessel must have safe means for a person boarding or disembarking from the vessel to a wharf, or other shoreside location, taking into account:

- (a) variations in wharf height; and
- (b) tidal range; and
- (c) movement of the vessel due to waves, wind or current; and
- (d) the surfaces to which a person is likely to require access.

**6.8.2 Access between a vessel and another vessel**

If transfer of a person from 1 vessel to another is likely or envisaged, safe means for affecting the transfer must be provided.

**6.8.3 Means of access to be appropriate**

The means of access to a vessel must be safe, taking into account the needs of at least 95% of the range of physical dimensions and capabilities of persons likely to use the vessel.

**6.8.4 Pilot transfer arrangements**

If pilot transfer is likely or envisaged, safe means for affecting the transfer must be provided.

**6.9 Required outcome — pilot launch design and equipment**

A pilot launch must be designed, fitted and equipped to ensure safe operation and safe pilot transfer.

**6.10 Required outcome — recovery of persons who fall overboard**

A vessel must have the means to enable a person overboard to be recovered on board without the person being exposed to additional risks.

**Deemed-to-satisfy solutions****6.11 Protection of persons from the elements****6.11.1 Protection from seas****6.11.1.1 Seas coming on board**

A vessel engaged in operational area A, B, C or D must be arranged and equipped:

- (a) to reduce the likelihood of seas coming on board; and
- (b) to mitigate the consequences of seas on board.

**6.11.1.2 Seas coming on board if people required to be on open deck**

If a person is required to be on an open deck for extended periods, the vessel must be arranged and equipped to prevent large quantities of seas coming on board in normal conditions, taking into account:

- (a) the area of operation; and
- (b) the activities undertaken on the deck; and
- (c) the range of conditions where a person is likely to occupy the deck.

**6.11.1.3 Protection of persons moving about the vessel****6.11.1.3.1 General requirement**

A vessel must have arrangements to protect persons from large quantities of seas coming on board if the height of the bulwark rail or deck edge beneath a

guardrail is inadequate to prevent seas coming onto a deck in the following conditions:

- (a) during normal conditions if the deck provides a pathway that is likely to be traversed by persons over the course of the vessel's ordinary operations;
- (b) during abnormal conditions if the deck provides a pathway that is essential for safety (eg access to a machinery space, life-saving equipment or anchor windlass).

#### **6.11.1.3.2 Requirement for vessels not subject to Load Lines Convention**

The means of safe passage on a vessel that is not subject to the Load Lines Convention must:

- (a) be appropriate to the demographic of persons (eg crew, passengers or others) likely to be exposed to the sea, and the likelihood of exposure; or
- (b) comply with **Table 28**.

*Note:* The Load Lines Convention has requirements for the protection of the crew and the means for safe passage of the crew on vessels to which it applies.

**Table 28 — Deemed-to-satisfy requirements for means of safe passage across exposed decks**

Measure	Deck subject to seas coming on board in normal conditions		Deck subject to seas coming on board only in abnormal conditions	
	Passengers	Crew	Passengers	Crew
Underdeck passages	Acceptable	Acceptable	Acceptable	Acceptable
Raised gangways	Acceptable	Acceptable	Acceptable	Acceptable
Harness, safety lines, clipping points and jack-stays — see clause 6.12.7.5	Not acceptable	Acceptable	Acceptable	Acceptable
Guardrails or handrails	Not acceptable	Not acceptable	Acceptable	Acceptable
Lifelines	Not acceptable	Not acceptable	Not acceptable	Acceptable

#### **6.11.2 Protection from the weather**

The following vessels must be provided with a cabin, enclosure or other permanent rigid structure to protect those on board from the weather:

- (a) an Operational Area A vessel;
- (b) an Operational Area B or C vessel engaged in passages of at least 12 hours;
- (c) a sheltered water vessel (Operational Areas D or E) engaged in passages of at least 36 hours.

## 6.12 Bulwarks and guardrails

### 6.12.1 Scope

This clause specifies minimum requirements for bulwark and guardrail heights on a vessel.

### 6.12.2 Application

A vessel must have bulwarks or fixed guardrails near the periphery of an exposed deck that a person or vehicle may access, unless additional conditions apply under clause 6.12.4.

### 6.12.3 Minimum height of bulwarks and guard rails

The minimum height of bulwarks and guard rails on a vessel must be in accordance with **Table 29**.

**Table 29 — Deemed-to-satisfy heights of bulwarks and guardrails**

Vessel measured length	General purpose deck (mm)	Special purpose deck (mm)	Special working deck (mm)
> 16 m	1000	800	600 as one option in <b>Table 30</b>
≤ 16 m	800	600	600 as one option in <b>Table 30</b>

### 6.12.4 Additional requirements for nominated special purpose and special working decks

A vessel must have the following measures for a special purpose deck or special working deck:

- (a) a deck nominated as a special purpose deck or special working deck must be provided with additional measures to maintain safety in accordance with **Table 30**;
- (b) additional safety measures for a special purpose deck or special working deck must be expressly documented in the vessel's safety management system.

**Table 30 — Additional requirements for nominated special purpose and special working decks**

Requirement	Special purpose deck		Special working deck	
	Seagoing Operational area A, B or C	Sheltered waters Operational area D or E	Seagoing Operational area A, B or C	Sheltered waters Operational area D or E
<b>Measure 1</b> Slip-resistant surface (see clause 6.12.7.2)	Applies	Applies	Applies	Applies

Requirement	Special purpose deck		Special working deck	
	Seagoing Operational area A, B or C	Sheltered waters Operational area D or E	Seagoing Operational area A, B or C	Sheltered waters Operational area D or E
<b>Measure 2</b> Foot-stop/toe rail if guard rail fitted (see clause 6.12.7.3)	Applies	Applies	Applies	Applies
<b>Measure 3</b> Handholds (see clause 6.12.7.4)	Applies	Applies	Applies	Applies
<b>Measure 4</b> Guardrails/bulwarks of minimum height in accordance with <b>Table 29</b>	Applies	Applies	Applies	Either Measure 4 or Measure 5
<b>Measure 5</b> Harnesses, safety lines, clipping points and jack- stays (see clause 6.12.7.5)	Applies	Either Measure 5, or Measures 7 and 8	Applies	Either Measure 5, or Measures 7 and 8
<b>Measure 6</b> Fixed seating for all persons on special purpose/special working deck (see clause 4.11.2.2)	Applies	Applies	Not Required	Not Required
<b>Measure 7</b> Wearing of lifejacket when on special purpose/ special working deck	Applies	Either Measure 7 or Measure 5	Applies	Either Measure 7 or Measure 5
<b>Measure 8</b> Person overboard alert system (applies only on vessels carrying 2 crew or more)	Applies	Not required	Applies	Not required
<b>Measure 9</b> Means of reboarding (see clause 6.12.7.6)	Applies	Applies	Applies	Applies



## 6.12.5 Maximum size of clear openings in bulwarks and guard rails

### 6.12.5.1 Guardrails

A vessel must have the following measures for guardrails:

- (a) a horizontal course must have an angle to the horizontal of not greater than 30°;
- (b) for a guardrail with intermediate horizontal courses — the courses are arranged so that the spacing between courses does not exceed the values mentioned in Table 31;
- (c) for a guardrail constructed without horizontal courses — the courses are arranged so that the maximum gap between palings, bars or other barrier elements does not exceed that which would allow a 125 mm diameter sphere to pass through the gap.

**Table 31 — Maximum permissible clear opening between horizontal courses**

Location	Maximum permissible opening (mm)			
	General purpose deck accessible by passengers with children less than 12 years old	General purpose deck for crew or passengers without children less than 12 years old	Special purpose deck	Special working deck
Between lowest course and the deck	230	230	230 to 300	Not specified
Between other courses	230	380	380	Not specified

### 6.12.5.2 Openings in bulwarks

An opening in a bulwark, including a freeing port, must be protected by bars or other barrier elements to limit the maximum dimension of any clear opening to no greater than that mentioned for guardrails in clause 6.12.5.1.

### 6.12.5.3 Additional protection on passenger deck of a ferry or excursion vessel

An opening in a bulwark or guardrail on a passenger deck of a ferry or excursion vessel must be fitted with arrangements that limit the size of a single clear opening below the top of the rail to not more than would allow the passage of a 125 mm diameter sphere.

## 6.12.6 Strength of guardrails

### 6.12.6.1 Guardrails generally

A guardrail must meet the following design and construction requirements:

- (a) a guardrail, other than one mentioned in clause 6.12.6.2, must be designed and constructed to withstand a point load of 890 N applied at any point in

any direction, and a uniform load of 725 N/m applied to the top rail in any direction;

- (b) if the guardrail includes a gate, it must meet the criteria with the gate open;
- (c) if glass is used in the construction of the guardrail, the design and construction of the guardrail must comply with Lloyd's Rules Part 4, Chapter 2, Section 12.

#### **6.12.6.2 Guardrails formed by horizontal courses of flexible wire or similar**

##### **6.12.6.2.1 Application**

A guardrail formed by horizontal courses of flexible wire may be fitted on a Class 1 vessel of less than 24 m length or a Class 2 or 3 vessel subject to clause 6.12.6.2.3.

##### **6.12.6.2.2 Stanchions**

Stanchions must be designed, arranged and constructed as follows:

- (a) the maximum spacing between stanchions must not exceed 2150 mm;
- (b) the horizontal courses must not pass outboard of a line angled at 10° from the vertical from a point located 50 mm above the intersection of the deck and the hull side;
- (c) the guardrail stanchions without courses must achieve the following when tested with the forces directed outboard at the point of intersection with the uppermost course and perpendicular to the guardrail direction at that point:
  - (i) the deflection must not exceed 50 mm at the point of application of the force when a horizontal force of 280 N is applied;
  - (ii) there must be no permanent deformation of the stanchion after the force mentioned in subparagraph (i) has been removed;
  - (iii) the stanchion must withstand a horizontal force of 560 N without breaking.

##### **6.12.6.2.3 Flexible horizontal courses**

A vessel must have the following measures for flexible horizontal courses:

- (a) each course of flexible wire or similar material used to form horizontal courses must have a minimum ultimate breaking strength of 13 kN for Operational Area A or B, or 9 kN for Operational Area C, D or E;
- (b) arrangements for tensioning to keep horizontal courses taut must be incorporated into the guardrail, of strength not less than the material used in the horizontal course;
- (c) the flexible wire or similar material used to form horizontal courses must be arranged so that it is visible for inspection purposes.

---

**6.12.7 Minimum specifications for the requirements for special purpose decks and special working decks listed in Table 30****6.12.7.1 Application**

Clauses 6.12.7.2 to 6.12.7.6 apply to a vessel that has a special purpose deck or a special working deck but only to the extent mentioned in clause 6.12.4.

**6.12.7.2 Slip-resistant surfaces**

A vessel must have the following measures for slip resistant surfaces:

- (a) deck areas must be slip-resistant;
- (b) slip-resistant surfaces need not be continuous;
- (c) the maximum spacing between slip-resistant patches must not be greater than 75 mm, except for glazed areas where the maximum spacing must not be greater than 500 mm, unless the lateral sides of the area are fitted with foot stops according to clause 6.12.7.3.

**6.12.7.3 Foot-stops and toe rails****6.12.7.3.1 Location**

A foot-stop or toe rail on a vessel must:

- (a) be provided along those outboard edges of the accessible portion of the deck; and
- (b) be as close as practicable to the outboard edges of the accessible portions of the deck.

**6.12.7.3.2 Minimum foot-stop or toe rail height**

For a foot-stops or toe rail on a vessel:

- (a) the height of the upper edge of the foot-stop or toe rail measured perpendicular to the adjacent working deck must be at least 25 mm; and
- (b) if the shape of the foot-stop or toe rail is configured other than to have a vertical upstand, the foot-stop must comply with *ISO 15085:2003 — Small craft — Man-overboard prevention and recovery*.

**6.12.7.3.3 Gaps in the foot-stop or toe rail**

- (1) A foot-stop or toe rail on a vessel may have gaps in the foot-stop or toe rail for the following:
  - (a) stanchions;
  - (b) pulpit feet;
  - (c) cleats;
  - (d) other similar fittings;
  - (e) water drainage.
- (2) Each gap must not be greater than 100 mm to the edge of the adjacent fitting, or foot stop or toe rail.
- (3) A fitting providing a foot-stopping action is a local foot-stop or toe rail.

**6.12.7.4 Handholds****6.12.7.4.1 Types of handholds**

Handholds on a vessel may be any of the following:

- (a) handrails;
- (b) overhead rails;
- (c) handles on fixed seats;
- (d) pillars;
- (e) cleated handrails on coachhouses.

**6.12.7.4.2 Requirements for handholds**

Handholds must:

- (a) be designed to facilitate a secure grip; and
- (b) be located having regard to the demographic characteristics of a person likely to use them; and
- (c) not be spaced more than 1.5 m apart; and
- (d) be capable of withstanding a horizontal force of 1500 N without any permanent yield or rupture.

**6.12.7.5 Harnesses, safety lines, clipping points and jack-stays****6.12.7.5.1 Scope**

Clause 6.12.7.5 specifies requirements for harnesses, safety lines, clipping points and jack-stays.

**6.12.7.5.2 Harnesses and safety lines**

If it is the applicable measure in accordance with Table 30, a vessel must have on board:

- (a) at least 2 harnesses; and
- (b) a safety line:
  - (i) of appropriate length for each person who is to use a special purpose deck or special working deck; and
  - (ii) that complies with AS 2227-2006 — *Yachting harnesses and lines — Conventional lines*.

**6.12.7.5.3 Deck accessways**

For an accessway leading onto a special purpose deck or special working deck, there must be clipping points or jack-stays for a person to clip on before coming on deck and unclip after going below deck.

**6.12.7.5.4 Clipping point location**

The following applies for clipping points:

- (a) if the option of hooking points and harnesses is adopted for a space, a clipping point must be provided at each place where persons work or otherwise occupy for long periods;

- (b) if a deck contains any of the features mentioned in **Table 32**, a clipping point must be provided within the distance mentioned in the table;
- (c) sufficient clipping points must also be provided so that they are located no more than 3 m apart.

#### **6.12.7.5.5 Clipping point size**

A clipping point must:

- (a) be designed to facilitate attachment by the harness hook; and
- (b) not exceed 15 mm diameter which is the maximum permissible dimension that can be accommodated within the inside of the harness hook.

**Table 32 — Requirement to fit clipping point**

<b>Feature</b>	<b>Location of clipping point</b>
Accessways to spaces inside the vessel	Within 1 m of the outside edge of accessway
Each steering position	Within 2 m
Each mast on a sailing vessel	Within 2 m
Each winch position on a vessel (including a sailing vessel) where the winches are likely to be operated underway	Within 2 m
The windlass	Within 2 m
Towing strong point	Within 2 m
Fishing positions and game fishing chairs on sports fishing vessels	Within 2 m

#### **6.12.7.5.6 Clipping point strength**

Clipping points as installed must withstand a horizontal force of 6 kN.

#### **6.12.7.5.7 Use of fittings as clipping points**

Clipping points do not need to be designed specifically for the purpose if they comply with clauses 6.12.7.5.4 to 6.12.7.5.6.

#### **6.12.7.5.8 Arrangement of jack-stays**

- (1) A vessel must have sufficient jack-stays allowing a person on a special purpose deck or special working deck to perform his or her functions.
- (2) A sailing vessel must have jack-stays port and starboard.
- (3) The jack-stays:
  - (a) must be arranged to minimise the need for clipping and unclipping; and
  - (b) may be in sections; and
  - (c) must have each section as long as practicable.

**6.12.7.5.9 Attachment points for jack-stays**

An attachment point must be:

- (a) fitted at the ends of each section of jack-stay; and
- (b) reliably attached to the structure of the vessel.

**6.12.7.5.10 Strength of jack-stays**

- (1) A jack-stay must be made of stainless steel wire, webbing or equivalent with breaking strength of at least 20 kN.
- (2) If made from stainless steel wire, the jack-stay must be uncoated and used without sleeving to facilitate monitoring of its condition.

**6.12.7.5.11 Strength of jack-stay attachment points**

An attachment point for a jack-stay must withstand a horizontal force of 20 kN applied in the direction of and up to an angle of 30° from a line connecting them.

**6.12.7.5.12 Use of fittings as attachment points for jack-stays**

An attachment point for a jack-stay need not be designed specifically for the purpose if it complies with clauses 6.12.7.5.8 to 6.12.7.5.11.

**6.12.7.6 Means of reboarding**

The vessel must have a means of reboarding that is:

- (a) accessible to, or deployable by, the person in the water without assistance from other persons and without the use of tools (eg ladders, steps, handholds, brackets); and
- (b) suited to the demographic characteristics of persons likely to need it; and
- (c) for passengers — a ladder or stairs having a lowest rung or step at least 300 mm below the worst case waterline; and
- (d) for a vessel with a special working deck but without a special purpose deck and having a minimum freeboard less than 500 mm — a single handhold, suitably located to allow reboarding, with consideration of the vessel's stability; and
- (e) installed remote from any propeller if practicable.

**6.13 Protection from hazardous plant****6.13.1 Definitions**

In this clause:

**plant** means any machinery, equipment appliance, implement or tool on the vessel, including any component, fitting or accessory.

### 6.13.2 Plant to be arranged for safe access

Plant must be arranged for safe access as follows:

- (a) the overall design of a space containing plant must be arranged to facilitate reasonable access to all items that may require inspection or attention in service;
- (b) passageways passing close to potentially hazardous elements of plant must be of sufficient width to minimise the risk of exposure to the hazards.

### 6.13.3 Shielding and guards

A vessel must have shields and guards to protect a person from exposure to hazardous elements of plant including moving parts, hot and cold surfaces and toxic substances in both normal and abnormal conditions of operation.

## 6.14 Safe movement of persons on vessels

### 6.14.1 Stairways, suspended walkways and ladders

#### 6.14.1.1 *Not part of an escape route*

Stairways and ladders for general access not forming part of escape or evacuation routes must comply with clause 5.13

#### 6.14.1.2 *Requirement for toe boards*

A suspended walkway that is more than 10 mm from a permanent structure and from which an object could fall more than 2 m must have a toe board at least 60 mm above the top surface.

#### 6.14.1.3 *Use only by crew for tending plant*

A stairway, ladder, suspended walkway or handrail that is used only by the crew for tending plant, may comply with either clause 6.14 or *AS 1657-1992 — Fixed platforms, walkways, stairways and ladders — Design, construction and installation*.

### 6.14.2 Walking surfaces

#### 6.14.2.1 *Removable walking surfaces*

Floor plates, gratings, ladders or other removable walking surfaces must be securely fitted and have a slip-resistant surface.

#### 6.14.2.2 *Openings located in walking surfaces*

Openings located in walking surfaces causing an unacceptable risk of injury must have guardrails or other means of protection.

## 6.15 Protection from excessive noise levels

A person on board a vessel must not be exposed to noise levels that exceed the levels permitted under the *Code on Noise Levels On Board Ships*.

## 6.16 Access to and from the vessel

### 6.16.1 Requirements for safe boarding and disembarkation

A vessel must:

- (a) have an accommodation ladder, gangway or gangplank in accordance with **Table 33**; or
- (b) alternative arrangements, to facilitate the safe boarding and disembarkation of persons.

**Table 33 — Deemed-to-satisfy requirements for accommodation ladders, gangways and gangplanks on vessels**

Area of operation	Vessel type	Length $\geq 120$ m	Length $\geq 35$ m and $\leq 120$ m	Length $\geq 15$ m and $< 35$ m	Length $< 15$ m
A	Class 1	Accommodation ladder	Accommodation ladder	Gangway	Gangway
	Class 2 or Class 3	Accommodation ladder	Accommodation ladder or gangway	Gangway	Gangway or gangplank
B	Class 1	Accommodation ladder	Accommodation ladder or gangway	Gangway	Arrangements as appropriate
	Class 2 or Class 3	Accommodation ladder	Accommodation ladder or gangway or gangplank	Gangway or gangplank	Arrangements as appropriate
C	Class 1	Accommodation ladder	Accommodation ladder or gangway	Gangway	Arrangements as appropriate
	Class 2 or Class 3	Accommodation ladder	Accommodation ladder or gangway or gangplank	Gangway or gangplank	Arrangements as appropriate
D	Class 1	Accommodation ladder or gangway	Accommodation ladder or gangway or gangplank	Gangway	Arrangements as appropriate
	Class 2 or Class 3	Accommodation ladder or gangway	Accommodation ladder or gangway or gangplank	Gangway or gangplank	Arrangements as appropriate
E	Class 1	Accommodation ladder or gangway	Accommodation ladder or	Gangway	Arrangements as appropriate



Area of operation	Vessel type	Length $\geq 120$ m	Length $\geq 35$ m and $\leq 120$ m	Length $\geq 15$ m and $< 35$ m	Length $< 15$ m
			gangway or gangplank		
	Class 2 or Class 3	Accommodation ladder or gangway	Accommodation ladder or gangway or gangplank	Gangway or gangplank	Arrangements as appropriate

### 6.16.2 General requirements for means of access

A means of access must be designed and constructed so that it:

- (a) is landed clear of the edge of the wharf or other potential hazards such as mooring lines; and
- (b) is positioned at an angle that will allow safe access to the vessel; and
- (c) is of strength sufficient to withstand loads in normal and abnormal conditions; and
- (d) is adequately secured to prevent accidental displacement; and
- (e) is positioned away from potentially hazardous activities such as cargo handling operations; and
- (f) allows for likely variations in quay levels, tidal levels and vessel freeboard; and
- (g) adjusts to allow for changing tidal levels and vessel freeboard if the access is to be deployed for longer periods; and
- (h) is illuminated throughout its length if used during the hours of darkness; and
- (i) protects persons from falling from the means of access, either from a height onto the wharf or between the vessel and the quayside.

### 6.16.3 Gangways

#### 6.16.3.1 Length

A gangway, if fitted, must be of sufficient length to ensure that when deployed during normal operations over the normal range of tide and vessel freeboards:

- (a) the landing of the gangway is kept well clear of the edge of the quayside; and
- (b) the angle of the gangway does not exceed the maximum permissible angle for cleated inclined ramps of  $30^\circ$ .

#### 6.16.3.2 Design and construction

##### 6.16.3.2.1 Applicable standards

A gangway must be designed and constructed to comply with:

- (a) *ISO 7061:1993 — Shipbuilding — Aluminium shore gangways for seagoing vessels*; or
- (b) clauses 6.16.3.2.2 and 6.16.3.2.3.

#### **6.16.3.2.2 Arrangement**

A gangway must be as follows:

- (a) either:
  - (i) if access for persons with disabilities is required by clause 4.11.4 — at least 800 mm in clear width; or
  - (ii) in any other case — at least 550 mm in clear width;
- (b) have a slip-resistant surface;
- (c) if intended for use at angles of 9° or more — fitted with transverse cleats at least 10 mm high and at equally spaced intervals not more than 330 mm apart;
- (d) have a suitable means to effectively secure the upper end;
- (e) if deployed and retrieved using a lifting appliance — fitted with suitable lifting attachments located to balance it when freely suspended.

#### **6.16.3.2.3 Side rails and stanchions**

A gangway must be fenced on each side of its entire length with upper and intermediate side rails:

- (a) with fixed rails, taut ropes or taut chains; and
- (b) at least 1000 mm high, measured from the walking surface (the surface of the treads if fitted) perpendicular to the longitudinal axis of the ladder with intermediate rails arranged so that the maximum clear gap does not exceed 600 mm; and
- (c) if the gap between the walking surface and the lowest intermediate course of rail exceeds 230 mm — with boards at least 60 mm above the walking surface; and
- (d) arranged so that any covering material used on ropes or chains is readily removable to allow inspection of their condition; and
- (e) supported by stanchions spaced not more than 2150mm apart, each fitted with a locking device to prevent accidental dislodgment.

#### **6.16.3.3 Strength**

A gangway must be designed and constructed to withstand:

- (a) a pressure of 5.5 kPa; and
- (b) if it provides access for persons with disabilities — a concentrated load of 5000 N at any point along its length.

**6.16.3.4 Landing**

If a gangway is to land on the top of a bulwark, side rail or other raised structure:

- (a) the bulwark, side rail or other structure must be of sufficient strength to bear the weight of the gangway and persons using it; and
- (b) it must have stairs and handrails or other means for safe access to the deck.

**6.16.3.5 Safety net**

If the difference in levels between the ends of the gangway exceeds 1.5 m, there must be safety nets:

- (a) of adequate length and width to prevent injury to a person falling from the gangway; and
- (b) composed of mesh of:
  - (i) breaking load not less than 1.23 kN, and
  - (ii) size such that the aperture of the mesh is more than 190 mm measured between opposite knots when the mesh is hung or cut to make it square mesh; and
  - (iii) constructed so that every corner of each mesh is secured to prevent movement; and
- (c) having a framing rope of at breaking load not less than 3.9 kN; and
- (d) resistant to actinic degradation (ie caused by solar radiation); and
- (e) secured in position at each corner, and intermediate points if required, by suitably secured lengths of framing rope.

**6.16.4 Gangplank****6.16.4.1 Application**

In addition to the requirements of **Table 33**, a gangplank must be limited to applications where:

- (a) the angle of the gangplank does not exceed 20° from the horizontal; and
- (b) the difference in levels between the ends of the gangplank does not exceed 1.5 m.

**6.16.4.2 General requirement**

A gangplank must comply with the requirements for gangways mentioned in clause 6.16.3 with the following modifications:

- (a) for a gangplank less than 2 m long — no guard rail is specified;
- (b) for a gangplank at least 2 m long — a single side rail must fitted;
- (c) no toe rail need be fitted.

**6.16.4.3 Cargo access ramp**

A cargo access ramp may be used as a means of access to and from a vessel if:

- (a) it has a slip-resistant surface marked for pedestrian use; and

- (b) the sides of the ramp are protected by guard rails or equivalent arrangements that provide adequate protection; and
- (c) either:
  - (i) the pedestrian area is effectively and protectively separated from the vehicular area; or
  - (ii) pedestrians are permitted to use the ramp only when the ramp is not in use by vehicles.

#### **6.16.5 Testing**

A gangway or gangplank:

- (a) must be tested for safe boarding and disembarkation by applying the loading mentioned in clause 6.16.3.3; and
- (b) is satisfactory if the gangway or gangplank does not fail or suffer permanent deformation after the load is removed; and
- (c) must be demonstrated to be safe by a practical trial of the arrangements for boarding and disembarkation, taking into account the variances likely in the vessel's operations.

#### **6.16.6 Pilot transfer arrangements**

A seagoing vessel of at least 50 m measured length must have safe pilot transfer arrangements complying with Regulation 23 of Chapter V of SOLAS in:

- (a) operational Area A; and
- (b) operational Area B; and
- (c) if the vessel is not to operate with a pilotage exemption — operational Area C.

### **6.17 Pilot launches**

#### **6.17.1 Pilot launch — design requirements**

A pilot launch must be constructed so that:

- (a) the deck that is used for access to the pilot transfer position is clear and free of obstructions; and
- (b) there is at least 750 mm between the gunwale and deckhouse or superstructure on the deck that is used for access to the pilot transfer position; and
- (c) the pilot transfer position is forward of the wheelhouse; and
- (d) from the launch master's normal driving position, the pilot and deck hand can be seen when they are outside the cabin; and
- (e) a person in the launch master's normal driving position has a clear view at every stage, of a pilot or deck hand moving from the cabin to the pilot transfer position or transferring the pilot's bags to or from the vessel; and
- (f) a person in the launch master's normal driving position can see the pilot:

- (i) when leaving the deck of the pilot launch and when ascending the pilot ladder; and
- (ii) when descending the pilot ladder and arriving on the deck of the pilot launch; and
- (g) the helm, engine controls and all other launch handling controls are at the normal driving position; and
- (h) normal access from the open deck to accommodation space for use of pilots is not through a forward facing weather tight door; and
- (i) all external walkways have an efficient non-slip surface; and
- (j) the external colour is substantially a highly visible colour and clearly marked with the word 'Pilot' on both sides of the vessel in letters at least 300 mm high.

#### 6.17.2 Pilot launch — fittings

A pilot launch must be fitted with the following:

- (a) for each seafarer on board the launch and for each pilot carried so that all people on board the launch may be seated simultaneously — 1 impact absorbing seat fitted with adjustable suspension and dampers to reduce shock loads and vibration;
- (b) seats allowing comfortable access to any controls and equipment required to be used by the launch master, seafarers or pilots;
- (c) a working air conditioner that can maintain a temperature in the range of 21°-25°C inside the cabin in all ambient weather conditions in the area of operation;
- (d) sound proofing so that ambient noise levels inside the accommodation, except the engine space, do not exceed 85 db when measured:
  - (i) at the height approximately equal to the level of a person's head while sitting in the impact absorbing seats provided; and
  - (ii) with the engines running at normal sea-going operating revolutions; and
  - (iii) with the doors closed; and
  - (iv) with the air conditioner running.

#### 6.17.3 Pilot launch — equipment

A pilot launch must be fitted with the following equipment:

- (a) fendering that:
  - (i) allows the pilot launch to come alongside vessels underway in all normal operating conditions without sustaining damage; and
  - (ii) does not interfere, obstruct or hinder pilot transfer; and
  - (iii) is continuous along gunwales; and
  - (iv) is not constructed using material that can become fouled on the pilot ladder or recovery line;

- (b) onboard lighting sufficient to ensure that operations can be conducted safely;
- (c) safety handrails on deck and inside the accommodation that are:
  - (i) capable of withstanding a load in either the vertical or horizontal direction of at least 1.2 kN; and
  - (ii) situated both inside and outside of the cabin so that a person can leave any of the impact absorbing seats provided in the cabin and move to the pilot transfer area with the continuous aid of the handrails;
- (d) an uninterrupted, continuous safety rail system:
  - (i) to which a lanyard or webbing strap capable of withstanding a load of 1.2 kN may be attached; and
  - (ii) that is located on each side of the accommodation to the pilot transfer area; and
  - (iii) that is capable of withstanding a load in either the vertical or horizontal direction of at least 1.2 kN; and
  - (iv) that allows a person in a safety harness to move freely along the safety rail without requiring the person to adjust his or her harness;
- (e) windscreen wipers situated in front of the launch master that are effective in rough weather and a fixed system for applying fresh water to the area of the forward windows covered by the wipers.

---

## **Annex A      Methodology for determining the minimum required aggregate width of doors, stairways, corridors and walkways serving a space**

(Table 19)

### **A1      Scope**

This Annex specifies a deemed-to-satisfy method for determining the minimum required aggregate width of doors, stairways, corridors and walkways serving a space.

It is a normative part of the standard.

### **A2      Application**

This Annex applies to escapes and evacuation paths on a vessel.

### **A3      Objective**

The objective of this Annex is to set out requirements that will facilitate:

- (a) the escape of all persons within a space from hazards that might arise within 5 minutes; and
- (b) the evacuation of all persons on a vessel into survival craft within 30 minutes from the issue of the order to abandon the vessel.

### **A4      Size of accessways**

The size of accessways must ensure that the calculated flow capacity of the accessway (clause A6) exceeds the required minimum flow of the accessway (clause A5).

### **A5      Required minimum flow through accessways**

The required minimum size of accessways must assume a time of passage of the first to the last person of 2 minutes and accommodate a flow of persons of a number determined as follows:

- (a) the number of persons accommodated within a space needing to use the access as an escape taking into account:
  - (i) the number of other similar accessways serving the space; and
  - (ii) the requirements for redundancy of flow capacity of escapes if there are more than 12 persons in the space; and
  - (iii) the contribution of any low capacity escapes that may also be installed to serve the space; and
  - (iv) crew on duty that reduce the average number of persons in a crew accommodation space by one third;

- 
- (b) the number of persons needing to use the accessway as part of an evacuation path taking into account:
    - (i) whether the path leads to an assembly station or directly to an embarkation station or whether it leads from an assembly station to an embarkation station; and
    - (ii) the number of persons progressively entering the evacuation path from spaces along the evacuation path; and
    - (iii) specified minimum widths for individual stairways, corridors, doors and walkways.

#### **A6 Calculated flow capacity of a single high capacity accessway**

The calculated flow capacity of a single accessway used as a high-capacity escape or evacuation path is:

$$N_A = 0.12(W_{AN} - 300)$$

where:

$N_A$  is the number of persons passing through the accessway.

$W_{AN}$  is the nominal width of the accessway not counting narrowing due to hand railings, in metres.

The values in **Table A.1** have been derived from this formula and are for ascertaining the flow capacity of a single accessway.

**Table A.1 — Calculated flow capacity of a single accessway**

Nominal width of single accessway (mm)	Calculated flow capacity (persons)	Nominal width of single accessway (mm)	Calculated flow capacity (persons)
700	48	1400	132
750	54	1450	138
800	60	1500	144
850	66	1550	150
900	72	1600	156
950	78	1650	162
1000	84	1700	168
1050	90	1750	174
1100	96	1800	180
1150	102	1850	186
1200	108	1900	192
1250	114	1950	198
1300	120	2000	204
1350	126	2100	216



Nominal width of single accessway (mm)	Calculated flow capacity (persons)	Nominal width of single accessway (mm)	Calculated flow capacity (persons)
2150	222	2400	252
2200	228	2450	258
2250	234	2500	264
2300	240	2550	270
2350	246	2300	240

*Note* Nominal width means the width of the accessway excluding any deduction from the intrusion of any handrails.

### A7 Person flow capacity for low capacity escapes

The deemed-to-satisfy person flow capacity of each low capacity escape is 18 persons.

### A8 Required combined flow capacity of escapes from a space

If a space is required to have more than 1 means of escape, the combined flow capacity of escapes serving the space is:

$$N_A^1 + N_A^2 + \dots + N_A^{N_E - 1} \geq N_{PE}$$

where:

$N_A^1, N_A^2, \dots, N_A^{N_E}$  is the calculated flow capacity of each escape serving the space, in accordance with clause A6 if high capacity or clause A7 if low capacity.

$N_A^1 + N_A^2 + \dots + N_A^{N_E - 1}$  is the assumed number of persons within the space.

$N_{PE}$  is the assumed number of persons within the space.

The values given in **Table A.2** have been derived from this formula. They are valid assuming a space is served by equally sized high capacity escapes without allowance for any low capacity escapes.

*Note 1* As the number of persons in a space increases, the provision of just 2 means of escape becomes increasingly impracticable. The green shaded cells show the optimum configuration based on minimum total width of escapes from the space.

*Note 2* If low capacity escapes also serve a space, the total number of persons assumed in the space may be reduced by 18 persons per low capacity escape.

**Table A.2 — Total nominal width of equally sized high capacity door escapes serving a single space assuming no low capacity escapes**

Number of persons in the space (see note 1)	Minimum total of the nominal widths of escapes serving the space (mm) (see notes 2 and 3)			
	2 exits	3 exits	4 exits	5 exits
72	1800	2700*	3600*	4500*
100	2267	2700*	3600*	4500*

Number of persons in the space (see note 1)	Minimum total of the nominal widths of escapes serving the space (mm) (see notes 2 and 3)			
	2 exits	3 exits	4 exits	5 exits
125	2683	2700*	3600*	4500*
150	3100	2775	3600*	4500*
175	3517	3088	3600*	4500*
200	3933	3400	3600*	4500*
250	4767	4025	3978	4500*
300	5600	4650	4533	4625
350	6433	5275	5089	5146
400	7267	5900	5644	5667
450	8100	6525	6200	6188
500	8933	7150	6756	6708
550	9767	7775	7311	7229
600	10600	8400	7867	7750

*Note 1* Only be 67% of the crew needs to be accommodated within a crew accommodation space.

*Note 2* Nominal width means the width of the accessway excluding any deduction from the intrusion of any handrails.

*Note 3* The table assumes escapes are all the same size — a larger value will be required where the sizes of escapes differ from one another.

\* Based on minimum 900 mm width of a door for each escape on a large passenger vessel. Passageways would be at least 100 mm wider and stairways at least 200 mm wider due to the intrusion of handrails.